

**ELECTRIC VEHICLE
BATTERY TEST PROCEDURES
MANUAL**

Revision 2

Published January 1996

Summary of Changes for USABC Manual Revision 2
(Not including minor editorial and typographical corrections)

PAGE	DESCRIPTION OF CHANGE
2, A-5	The list of Core Performance Tests is clarified in Figure 1, and the test plan outline is clarified to note that written direction from the USABC Program Manager is needed to bypass these tests. The number and type of core tests required is NOT changed.
6, E-2, F-3, F-5	A single ' Rated Capacity ' value is clearly defined as the basis for measuring depth-of-discharge (and hence capacity) for all USABC performance tests. The Rated Capacity is established by the manufacturer based on whatever tradeoffs he chooses to make for the best balance of power, capacity and life.
6, A-1	Both USABC Test Manager and Program Manager approval are required for all test plans.
9, E-3, F-5, I-3	The Discharge Voltage Limit (DVL) for the Peak Power Test is clarified to be a fixed value established at beginning of life. An alternate equation for calculating Peak Power Capability is added to account for decreases in open circuit voltage beyond 80% DOD or later in life. Conduct of the Peak Power test itself is NOT changed except for requiring voltage to stay above the DVL.
13, 15, 40	Discharge Voltage Limit is a default termination condition for FUDS, DST and Life Cycle Testing.
15	The DST procedure is modified to eliminate the reduced power criterion for Step 15. All steps are now treated the same (as in the FUDS test); and the test terminates when the programmed power cannot be achieved for any step without exceeding a battery limit.
15, F-6	The terminology DST_n is established to indicate the peak power scaling for a DST test, e.g. DST_{120} is a test scaled to 120 W/kg.
22ff, J-34ff	A vibration test using random vibration is added to Procedure 10. The existing swept sine wave vibration test is retained unchanged as an alternative.
31, 35, 37, 39, 40	The interval for conducting Reference Performance Tests during life cycle test regimes is generalized to an appropriate interval rather than fixed at 28 days.
35	The method for counting the number of cycles achieved during life testing of a battery is formalized.
37, 38	The Actual Use Simulation test is extended to include the effects of ambient temperature variation , and temperature test regimes are established based on historical data from specific hot and cold weather locations.
40	The Baseline Life Cycle Test is defined based on DST cycling to 80% DOD at nominal environmental conditions. (This test is already being widely used.)
F-7	End-of-life is clarified to occur when either the net DST delivered capacity or peak power capability at 80% DOD is less than 80% of rated.
Appendix F	A detailed glossary of terminology is included.
Appendix I	An explanation of the method and rationale for calculating Peak Power Capability is provided.
Appendix J	Detailed procedures (previously issued separately) are included to supplement some procedure summaries, and the special procedure previously proposed for resistance determination is deleted.

ELECTRIC VEHICLE BATTERY TEST PROCEDURES MANUAL



TABLE OF CONTENTS

Foreword	iv
Introduction	1
Outline and Flow Diagram of USABC Testing Process	2
Battery Test Procedure Summaries	4
Organization Chart of USABC Battery Test Procedures	5
1A. Battery Pre-Test Preparation	6
1B. Readiness Review	7
* 2. Constant Current Discharge Test Series	8
▼ * 3. Peak Power Test	9
* 4. Constant Power Discharge Test	11
* 5. Variable Power Discharge Testing [Overview]	12
▼ 5A. FUDS Regime (Variable Power Discharge)	13
▼ 5B. DST Regime (Variable Power Testing)	15
6 - 12. Special Performance Tests [Overview]	17
▼ 6. Partial Discharge Test	18
▼ 7. Stand Test	19
8. Sustained Hill-Climbing Power Test	20
▼ 9. Thermal Performance Test	21
▼ 10. Battery Vibration Test	22
11. Charge Optimization Testing	27
12. Fast Charge Test	28
13. Safety and Abuse Testing	29
14. Life Cycle Testing [General]	31
14A. Accelerated Aging Testing	33
14B. Actual-Use Simulation Test including Ambient Temperature Influence	37
14C. Reference Performance Tests	39
14D. Baseline Life Cycle Test	40

(▼ indicates that detailed procedures are available in Appendix J)

(* indicates core performance tests - see Appendix A Section 7.2 for details)

Appendices

A. Generic Test Plan Outline for USABC Battery Testing	A-1
B. Definition of Data Acquisition and Reporting Requirements	B-1
C. DOE National Laboratory Test Facilities Listing	C-1
D. Methodology for Assigning USABC Identification Numbers	D-1
E. Worksheet for Manufacturer-Supplied Testing Information	E-1
F. Glossary of Battery and Battery Testing Terminology	F-1
G. USABC Advanced Battery Criteria	G-1
H. Procedure to Measure Actual Peak Power	H-1
I. Derivation of USABC Battery Peak Power Calculations	I-1
J. Detailed Procedures	J-1

FOREWORD

This USABC Battery Test Procedures Manual was prepared by a team composed of USABC and DOE National Laboratories personnel. It is based on the experience and methods developed at Argonne National Laboratory (ANL), Idaho National Engineering Laboratory (INEL) and Sandia National Laboratories (SNL). The specific procedures were developed primarily to characterize the performance of a particular battery relative to the USABC mid term and long term battery requirements. The principal contributor and author of this document is Gary Hunt of INEL. Although it is used as a "standard" for USABC battery testing, a continuing need to improve these procedures is expected. Suggestions should be directed to Gary Hunt, INEL, telephone number 208-526-1095.

Battery Test Procedure (BTP) Working Group Contributors

USABC

Helen Cost
Pat Davis (DOE)
Edward Dowgiallo (DOE)
Matthew Dzieciuch
Michael Eskra
Harold Haskins
Bernie Heinrich
Russell Moy
Jim Pass
Naum Pinsky
Bruce Rauhe
Bill Schank
Ray Sutula (DOE)
Robert Swaroop
Tom Tartamella
John Williams

National Laboratories

Jeffrey Braithwaite
Paul Butler
William De Luca
Narayan Doddapaneni
James Freese
Jasper Hardin
Gary Hunt
John Smaga

INTRODUCTION

This manual summarizes the procedural information needed to perform the battery testing being sponsored by the United States Advanced Battery Consortium (USABC). In this manual, the general term battery refers to full-voltage battery packs, modules, and cells. This information provides the structure and standards to be used by all testing organizations, including the USABC developers, national laboratories, or other relevant test facilities.

The structure of the USABC testing process is shown in Figures 1 and 2. These figures represent two methods for describing the same process: Figure 1 is an outline and Figure 2 is a flow diagram. The numbers on the right side of Figure 1 refer to the applicable USABC Test Procedure. In narrative terms, the process consists of the following general steps: (1) receipt of the battery or test unit and preparation of a detailed test plan, (2) commissioning according to manufacturer's recommendations, (3) electrical performance tests that include a set of mandatory core tests along with optional general and/or special tests, (4) either (a) life-cycle testing or (b) typically destructive safety/abuse testing, and (5) post-test analysis. Steps 4 and 5 are optional and will not be used with some batteries. The mandatory set of core-performance tests in Step 3 is defined in Appendix F and described in Appendix A.

The principal part of this manual is the compilation of individual test procedure summaries that follow this section. The organization of these procedures in relation to the general steps defined in the previous paragraph is shown in Figure 3. A few specific procedures are not yet completely developed; these are identified by notes in the applicable section. For example, the test procedures for characterizing general electrical performance are defined in some detail, while the methodology for planning an accelerated life test sequence is only broadly described.

The following appendices are included in this manual for reference and use by the test program planner and the testing organization:

- A. Outline of Generic Test Plan (to be used in the definition of required testing for all battery test units)
- B. Definition of General Data Acquisition and Reporting Requirements
- C. Listing of DOE National Laboratory Test Equipment Capability
- D. Methodology for Assigning USABC Identification Numbers
- E. Worksheet for Manufacturer-Supplied Testing Information
- F. Glossary of USABC Testing Terminology
- G. USABC Advanced Battery Criteria (Goals)
- H. Procedure to Measure Actual Peak Power
- I. Derivation of USABC Battery Peak Power Calculations
- J. Detailed Procedures

Figure 1. Outline of USABC Laboratory Battery Testing Process

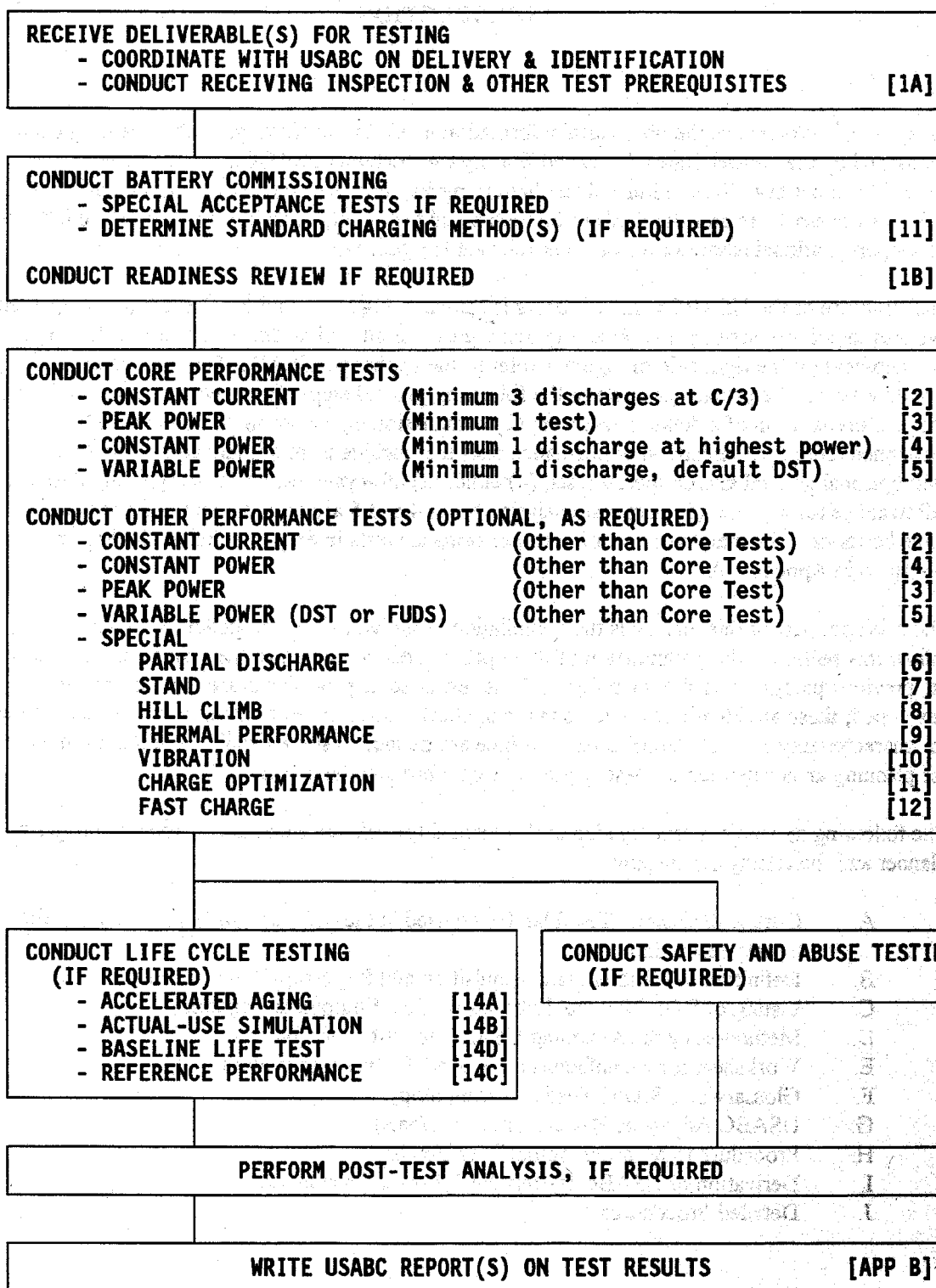

Note: Numbers in brackets [] are procedure numbers, refer to Table of Contents.

Figure 2. USABC Battery Test Flow Diagram

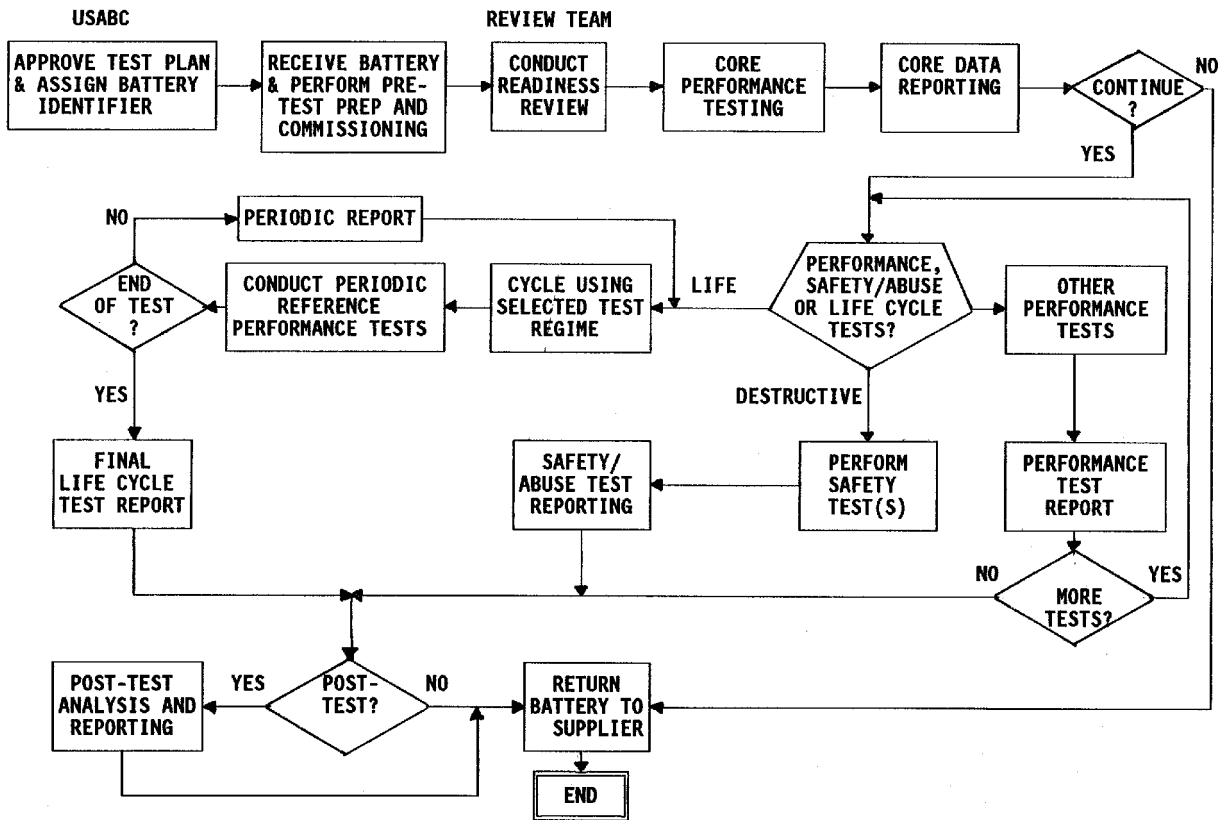

USABC
ELECTRIC VEHICLE
BATTERY TEST PROCEDURE
SUMMARIES

Figure 3. Organization Chart of USABC Battery Test Procedures

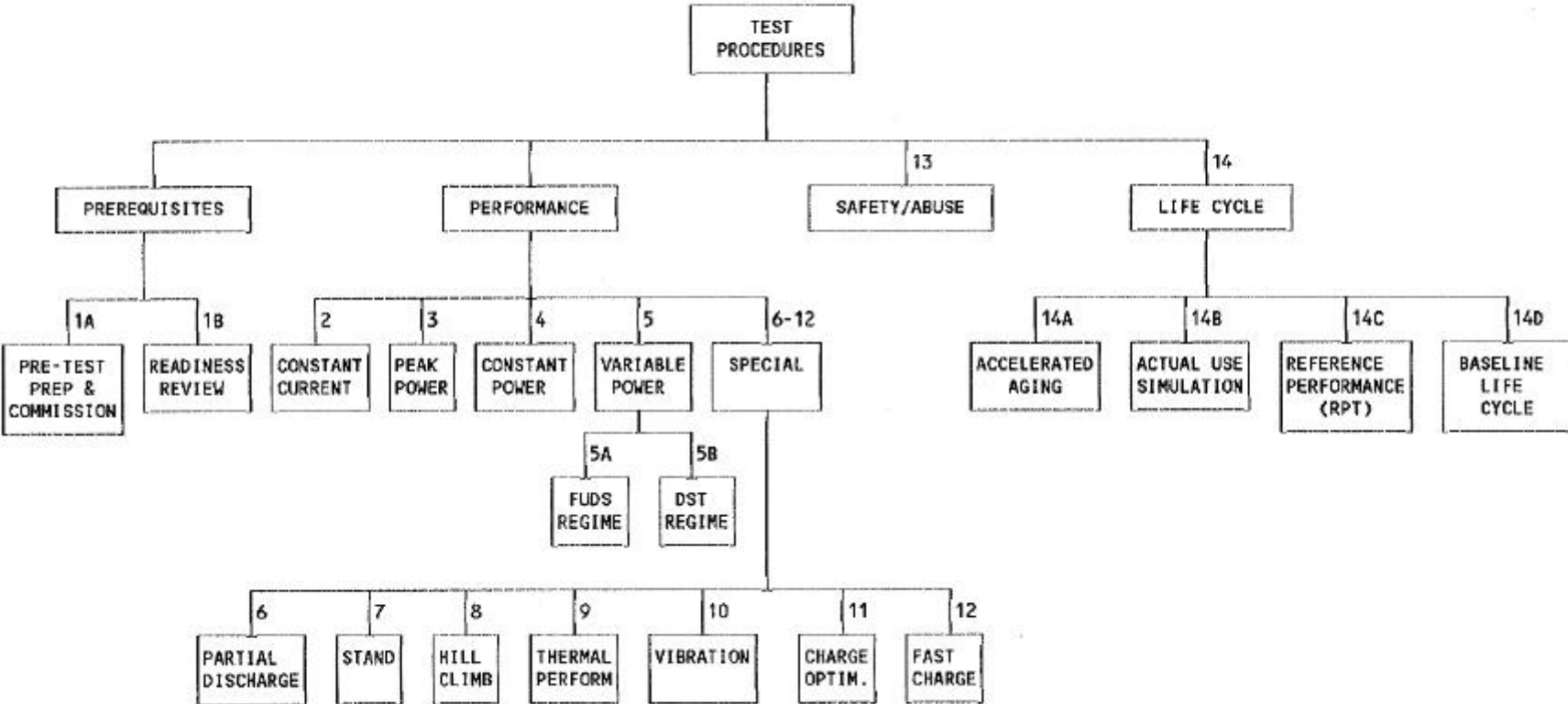

BATTERY PRE-TEST PREPARATION

Purpose:

The purpose of pre-test preparation is to assure that information required for testing a new battery (deliverable/test unit) is available and that tasks to be accomplished prior to actual start of testing are complete.

Abstract:

The USABC Program Manager(s) or his designee will procure all batteries to be tested, assign identification (ID) numbers, and provide these numbers to the USABC Test Manager for archiving. The process for assigning ID numbers is detailed in Appendix D. Delivery of the test units will be coordinated between the testing laboratory and the USABC Program Manager. Prior to receipt of test units by the testing laboratory, a Test Plan will be established, and approved by the USABC Program Manager and Test Manager (generic outline in Appendix A). This plan will include at least the following specifications and instructions:

- (1) Specific types and number of tests required
- (2) Battery ratings, measurements and test termination limits, provided by the manufacturer, as detailed in the Worksheet in Appendix E. **Note that a single “Rated Capacity” value is used for measuring depth of discharge for all USABC performance Tests.** (See Rated Capacity in Appendix F.)
- (3) Charge procedure recommended by the manufacturer (in Worksheet)
- (4) Peak discharge power to be applied for DST or FUDS testing
- (5) Peak current or power values or other special conditions to be used during Life Cycle and Reference Performance Tests (if different from standard performance test conditions)
- (6) Changes to standard test procedures (if any) to be required due to developmental battery limitations (justification required)
- (7) Thermal enclosure or other battery management system handling instructions (if applicable)
- (8) Test laboratory Readiness Review requirement
- (9) Commissioning instructions and operating manual/instructions

Pre-testing activities during receiving inspection at the test laboratory will include damage inspection, battery/cell/module dimension and weight measurements, and a leakage/isolation test against the USABC trial criterion of 1.0 mA or less at 500V DC (i.e. 0.5 MΩ or greater isolation.) The ground fault test is to be repeated periodically during testing of a battery. A test readiness review will be conducted (if required) by an external team in accordance with a Readiness Review Procedure (#1B)

Data Acquisition and Reporting Requirements:

The general requirements are given in Sections 2 and 3 of Appendix B, Reporting and Data Acquisition Outline. In addition, a written log book is to be maintained for each test unit or set of units. Descriptive information on all significant pre-test activities/results extracted from the Battery Test Log is to be reported.

READINESS REVIEW

Purpose:

A battery test readiness review is an assessment of the preparations and procedures necessary for conducting the test plan for a specific battery in a particular laboratory. The need for a readiness review will be determined by the USABC Program Manager based on criteria such as the value of the battery to be tested, the program impact if it were inadvertently damaged or destroyed, and the potential for safety or environmental problems to arise during the planned testing.

Abstract:

A Readiness Review is conducted on-site at the test laboratory by a team consisting of the following:

- Team Leader (USABC Program Manager or designee)
- USABC Test Manager
- Other USABC representative, as appropriate
- DOE and EPRI representatives, as appropriate
- Battery testing managers from ANL, INEL, and SNL (except that these lab managers shall not be members of the review team when their lab is the test laboratory.)
- Manufacturer's representatives, as appropriate

The team will review:

1. Relevant documents, including test plan, procedures, and safety documents
2. Test unit hardware condition (as appropriate)
3. Operational systems, including facility, data acquisition, test equipment and interfaces to test unit hardware, and personnel training/knowledge of all the above (annual review only)

A standard check list will be used, supplemented as needed by a list of battery specific concerns provided by the manufacturer and/or prepared by the review team.

Data Acquisition and Reporting Requirements:

No test data are required. A report of the review team's findings and recommendations, including the completed check list is to be sent to the responsible program manager.

CONSTANT CURRENT DISCHARGE TEST SERIES

Purpose:

The purpose of constant-current testing is to determine the effective capacity of a test unit using very repeatable, standardized conditions. A series of current levels can be applied to simply characterize the effect of discharge rate on capacity. A specific test at the 3-hour rate is included as a mandatory core performance measurement to verify the capacity rating of all test units. These tests do not necessarily establish the actual (maximum) capacity of the battery.

Abstract:

The battery will be charged in accordance with the method specified in the Test Plan. If this method is unavailable or a stable capacity is not obtained during these tests, perform Procedure #11, Charge Optimization. The battery will be put on open circuit for a period specified in the test plan to allow the battery to reach the specified starting test temperature. The preferred test sequence consists of performing groups of three constant current discharge cycles (with recharge as soon as practical after discharge) at each of $C_3/3$ amperes, $C_2/2$ amperes, $C_1/1$ amperes, and $C_3/3$ amperes with the battery at $23^\circ \pm 2^\circ\text{C}$ (or as specified in the Test Plan) at the start of discharge. For subsequent testing, the battery capacity is considered stable when three successive $C_3/3$ discharges agree within 2%.

Each discharge will terminate when either the rated capacity or the minimum discharge voltage (or other termination condition) specified by the manufacturer, whichever occurs first, is reached.

Data Acquisition and Reporting Requirements:

The general requirements are given in Section 4 of Appendix B, Reporting and Data Acquisition Outline. Specific data deliverables include a Peukert Plot, if a full series of tests is performed; however, this plot is not necessarily meaningful if the rated capacity of the battery is less than the available capacity at the various discharge rates. If the available capacity measured by this procedure is less than the rated capacity for a given discharge rate, the average of 3 tests at that rate should be reported.

PEAK POWER TEST

Purpose:

The purpose of this test is to determine the sustained (30s) discharge power capability of a battery at 2/3 of its OCV (see Terminology on next page) at each of various depths of discharge (DOD). The value calculated at 80% DOD is particularly important because this is the point at which the USABC power goal is defined, and the technology performance at this point is compared with this goal. This procedure does **not** measure the actual peak power of the battery. If this information is needed (e.g., for determining peak power rating), refer to Appendix H.

Abstract:

The peak power test is to be performed at 10 depths-of-discharge, from 0% DOD to 90% DOD in 10% intervals, **during a single discharge**. These DOD values are achieved by successively discharging the battery from a fully charged state to each % DOD at the Base Discharge Rate (see Terminology on next page). After the 90% DOD step sequence is performed, the battery is to be discharged at the Base Discharge Rate to 100% of its rated capacity (assuming this can be done without exceeding other discharge limits.) This test is performed with no regenerative energy applied to the battery.

At each specified DOD, discharge the battery for 30 seconds at the High Test Current (see Terminology on the next page.) Figure 3-1 following illustrates this sequence of steps. The same current values are used at all 10 DOD levels. However, the battery must remain above the Discharge Voltage Limit during each step, even if the step current has to be reduced. (Discharge Voltage Limit is established only once at beginning of life; see Terminology.) Note that the battery is to be discharged for 30 seconds at the Base Discharge Rate before applying the first (0% DOD) High Test Current step.

The peak power capability (at a given DOD) can be calculated by deriving the battery resistance and equivalent IR-free voltage from measured changes in battery voltage and current at that DOD. As noted by the arrows in Figure 3-1, voltage and current for these calculations are measured just prior to and then near the end of each High Test Current step to obtain the ΔV and ΔI values for that DOD. Note that discharge current (and thus discharge power and capacity, for consistency) is negative by convention; see Appendix I. Battery resistance and IR-free voltage are computed as follows:

$$\text{Battery resistance: } R = \Delta V \div \Delta I$$

$$\text{Battery IR-free Voltage: } V_{\text{IRFree}} = V - IR$$

Peak Power Capability is then the **minimum** negative value calculated from any of the following four equations:

$$\text{Peak Power Capability} = (-2/9) \cdot (V_{\text{IRFree}}^2) \div R$$

or

$$\text{Peak Power Capability} = - \text{Discharge Voltage Limit} \cdot (V_{\text{IRFree}} - \text{Discharge Voltage Limit}) \div R$$

or

$$\text{Peak Power Capability} = I_{\text{MAX}} \cdot (V_{\text{IRFree}} + R \cdot I_{\text{MAX}})$$

or

$$\text{Peak Power Capability} = \text{Actual Power at end of step (only if voltage or current limiting occurs)}$$

See Appendix I for a more detailed explanation and rationale for these calculations. If voltage limiting is encountered, the High Test Current for subsequent steps during a discharge may be reduced (depending on equipment limitations) to a value that will permit the remaining steps to be done at constant current (i.e. without further limiting taking place.)

If the Base Discharge Rate cannot be achieved at any point during the discharge without dropping below the Discharge Voltage Limit, the discharge is terminated.

Terminology:

OCV is Open Circuit Voltage (at a given Depth of Discharge), normally determined by test at beginning of life.

The **High Test Current** is the lesser of:

- (a) the Maximum Rated Current for the battery, or
- (b) 80% of (Rated Peak Power) ÷ (2/3 OCV @ 80% DOD at beginning of life)

The **Discharge Voltage Limit** is the greater of:

- (a) the manufacturer's minimum voltage limit at the discharge rate used; or
- (b) 2/3 OCV at 80% DOD at beginning of life

The **Base Discharge Rate** is a current which, when combined with the High Test Current 30 second pulses, results in a C/3 average discharge. Based on rated capacity C_{rated} (in Ah, negative by convention for this calculation), this current is calculated as follows:

$$I_{base\ discharge} = (12 * C_{rated} - I_{high\ test\ current}) \div 35$$

I_{MAX} is the manufacturer's Maximum Rated Current, if specified.

Data Acquisition and Reporting Requirements:

The general requirements are given in Section 4 of Appendix B, Reporting and Data Acquisition Outline. Specific data requirements include (1) the measurement of voltage and current at 1-second intervals 30 seconds before, during, and 30 seconds after the High Test Current discharge step for each DOD level, and (2) a plot of Peak Power Capability versus actual DOD corresponding to the end of each High Test Current step. Plots of the calculated V_{IRFree} and resistance versus actual DOD are also desirable.

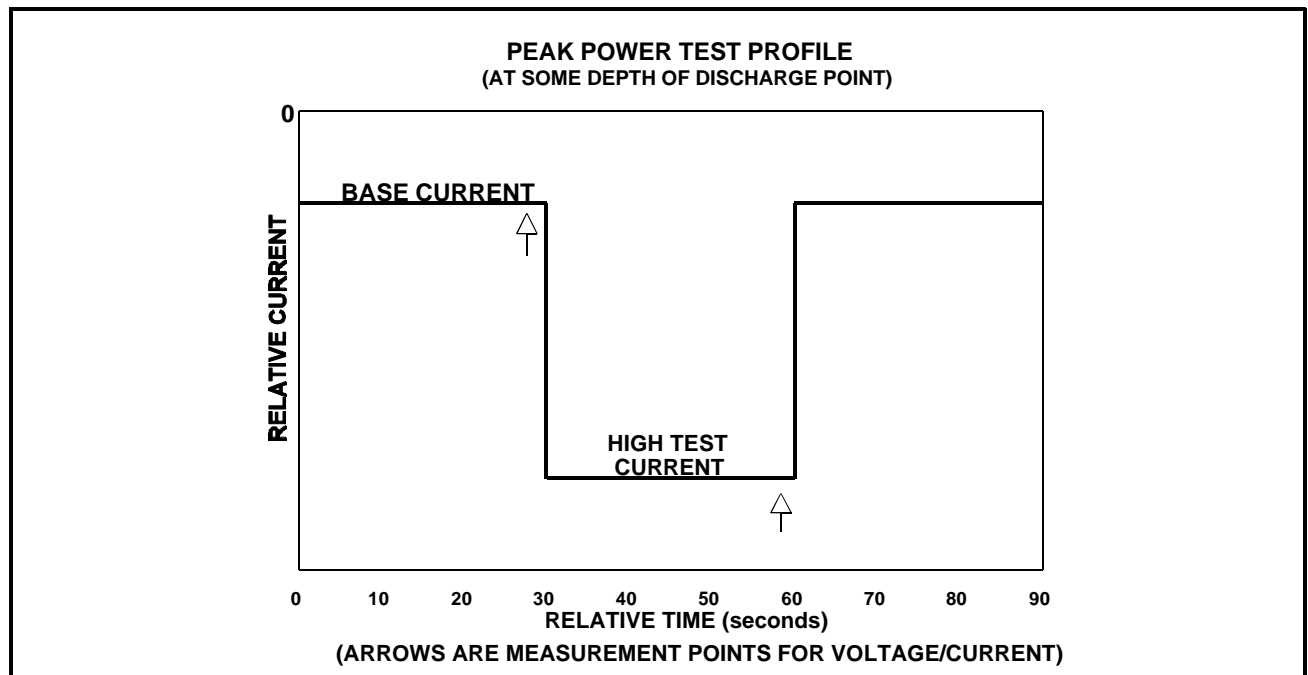

Figure 3-1. Peak Power Test Step

CONSTANT POWER DISCHARGE TEST

Purpose:

The purpose of this testing is to perform a sequence of constant power discharge/charge cycles that define the voltage versus power behavior of a battery as a function of depth of discharge. This testing characterizes the ability of a battery to provide a sustained discharge over a range of power levels representative of electric vehicle applications. Constant power discharges are similar to constant speed vehicle operation in their effect on a battery.

Abstract:

Prior to performing this test procedure, the constant-current portion (#2) of core performance testing should be completed to verify stable capacity. The battery must be completely charged prior to each discharge, and the battery temperature at start of discharge must be at $23^{\circ}\text{C} \pm 2^{\circ}\text{C}$ (or the operating temperature specified by the test plan.) For a full constant-power set, the battery will be discharged at a minimum of 3 power levels. The maximum power level is nominally that required to remove 75% of the rated energy from the battery in 1 hour. The reduced power levels are 2/3 and 1/3 of this maximum power level, respectively (50% and 25% of rated energy).

At each power level, discharge the battery to rated capacity or the specified termination point, whichever comes first, a minimum of 2 times (i.e. 6 or more discharge/charge cycles total.) If the test plan so specifies, it is permissible to terminate the highest power test after 1 hour; however, this test is normally done to the rated capacity. If one of the rates of discharge results in overheating or any other condition outside the battery operating limits, **do not** complete the discharge at that rate. However, the requirement to perform discharges at 3 power levels still applies.

Data Acquisition and Reporting Requirements:

The general requirements are given in Section 4 of Appendix B, Reporting and Data Acquisition Outline. Specific data deliverables include a Ragone plot (specific energy vs. specific power) and plots of energy vs. power and voltage vs. current at various % DOD levels. (Note that the Ragone plot is not necessarily meaningful if the rated capacity of the battery is less than the available capacity.) If a discharge cannot be completed at the normal maximum power level, this must be noted.

VARIABLE POWER DISCHARGE TESTING (Overview)

Purpose:

Variable power discharge testing is used to produce the effects of electric vehicle driving behavior (including regenerative braking) on the performance and life of a battery. The variable power discharge regimes specified under this procedure are based on the auto industry standard Federal Urban Driving Schedule, a complex 1372 second time-velocity profile originally based on actual driving data. However, to permit actual battery discharge/charge profiles to be determined, a number of approximations and simplifications to the actual FUDS profile had to be made.

Abstract:

The following two variable power discharge regimes have been defined for USABC testing:

1. FUDS - a second-by-second dynamic regime calculated using the FUDS vehicle time-velocity profile with a hypothetical electric van having a peak power demand of 111 W/kg and average power of about 10 W/kg. The actual profile used for testing, sometimes referred to as FUDS79, is derived by artificially limiting the peak power demand to 79 W/kg. This "clipped" power profile can then be scaled to any desired maximum power demand.
2. DST (Dynamic Stress Test) - a simplified variable power discharge cycle with the same average characteristics as the FUDS regime. The DST uses a 360 second sequence of power steps with only 7 discrete power levels.

Summaries for each specific procedure are included as #5A and #5B, respectively.

Data Acquisition and Reporting Requirements:

Refer to the applicable individual Procedure Summary (#5A and #5B).

FUDS REGIME (VARIABLE POWER DISCHARGE)

Purpose:

This variable power discharge regime represents the best simulation available of actual power requirements from an electric vehicle. It is a demanding profile with respect to the frequency of occurrence of high power peaks and ratio of maximum regenerative charging to discharge power.

The Federal Urban Driving Schedule (FUDS) is an automobile industry standard vehicle time-velocity profile for urban driving that has been used for a number of years for electric vehicle performance testing. It is identical to the EPA Urban Dynamometer Driving Schedule defined in 40 CFR Part 86 Appendix I. This FUDS velocity-time profile was converted into a battery power-time profile for a specific vehicle, the Improved Dual Shaft Electric Propulsion (IDSEP) minivan. Figure 5A-1 shows the resulting battery power profile, computed from the FUDS and scaled to Percent of Peak Discharge Power. In this computation, the specific power was artificially limited to 79 W/kg.

Abstract:

The battery will be charged and temperature stabilized in accordance with the manufacturer's recommended procedure or as otherwise specified in the test plan. Commencing from full charge, the battery will be discharged by applying the FUDS power profile, scaled to a maximum test power as specified in the test plan (nominally 120 W/kg for midterm batteries). The 1372 second FUDS test profiles (as defined in Appendix J) are applied continuously end-to-end with no time delay (rest period) between profiles until the end-of-discharge point specified in the test plan has been reached. This normally will be the rated capacity (in A·h) or a battery limit, such as the Discharge Voltage Limit, whichever occurs first. If the power required for any step of the profile cannot be attained, the discharge is to be terminated. No reduced power criteria exist for this test. The end-of-discharge point is based on **net** capacity removed (total A·h minus regeneration A·h). The battery will be fully recharged as soon as practical in accordance with established charging procedures and temperature constraints in preparation for continuing testing. If the possibility of test unit damage exists due to regeneration, limits on regen power, current or voltage may be imposed by the test plan and reported.

Data Acquisition and Reporting Requirements:

The general requirements are given in Section 4 of Appendix B, Reporting and Data Acquisition Outline. Specific data deliverables include the value of the maximum power step, the number of profiles completed, and any deviations from the procedure (e.g. reduced regen limits).

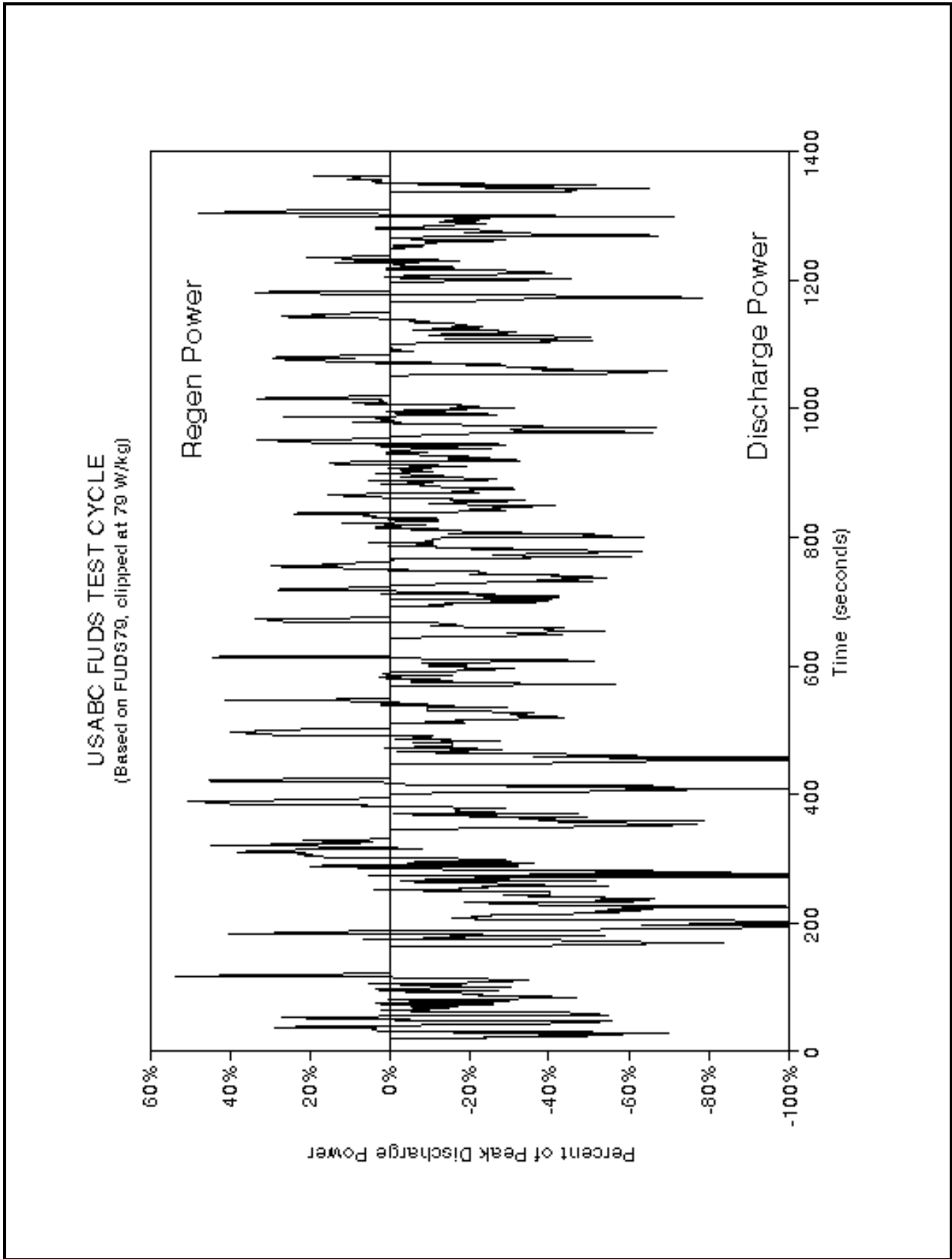

Figure 5A-1. FUDS Power Profile

DST REGIME (VARIABLE POWER TESTING)

Purpose:

This variable power discharge regime is a simplified version of the FUDS-based power-time demand (Procedure #5A). This specific regime can effectively simulate dynamic discharging and can be implemented with equipment at most test laboratories and developers.

A simplified version of the FUDS regime (SFUDS) was developed by the DOE/EHP Battery Test Task Force (BTTF) in 1988. The original SFUDS was derived for a specific vehicle, the Improved Dual Shaft Electric Propulsion (IDSEP). For driving-cycle testing of USABC batteries, the SFUDS profile was modified into the Dynamic Stress Test (DST). The DST is (1) scaled to a percentage of the maximum rated power or USABC power goal, and (2) requires higher regeneration levels than the SFUDS cycle. Figure 5B-1 shows a graphical representation of a generic DST test profile, while Table 5B-1 tabulates the corresponding values. In general, 100% on this graph or table is intended to be 80% of the USABC peak power goal (at 80% DOD) for a technology; however, the test may be performed based on manufacturer's ratings in some cases. As an example, if this profile is scaled to 80% of the USABC midterm goal of 150 W/kg, it would have a peak power of 120 W/kg and an average power of 15 W/kg. A lower power version of this profile may be used for testing batteries that cannot be operated at the nominal peak power requirement. The test is designated DST_n, where n is the scaled peak power value in W/kg. (See Appendix F.)

Abstract:

The battery will be charged and temperature stabilized in accordance with the manufacturer's recommended procedure or as otherwise specified in the test plan. Commencing from full charge, the battery will be discharged by applying the scaled DST power profile. The 360 second DST test profiles are repeated end-to-end with no time delay (rest period) between them. The maximum permissible transition time between power steps is 1 second, and these transition times are included in the overall profile length (i.e., a DST test profile is always 360 seconds long). This discharge regime is continued until either the end-of-discharge point specified in the test plan or inability to follow the test profile within a battery limit, whichever occurs first, has been reached. End-of-discharge is normally specified as: (a) the rated capacity in A·h, for performance or Reference Performance Tests; or (b) 80% of the rated capacity in A·h, for baseline life cycle tests. The end-of-discharge point is based on net capacity removed (total A·h - regeneration A·h). (See definition of 'rated capacity' in Appendix F.)

If the programmed power value for any step of the test profile cannot be performed within the Discharge Voltage Limit or other specified battery limits, the discharge is terminated at that point.

Note: the reduced power criterion for Step 15 used in the original version of this test is no longer required or permitted. The battery will be fully recharged as soon as practical after discharge unless the test plan requires otherwise. If the possibility of test unit damage exists due to regeneration, limits on regen power, current or voltage may be imposed by the test plan and reported.

Data Acquisition and Reporting Requirements:

The general requirements are given in Section 4 of Appendix B, Reporting and Data Acquisition Outline. Specific data deliverables include the value of the maximum power step, the number of profiles completed, the capacity of the test unit (both gross and net A·h and kW·h), and any deviations from the procedure (e.g. reduced regen limits, where they are encountered and the capacity where such reductions are not in effect.) Note that the designation DST_n should be used to report the

scaled peak power level for a DST test e.g., DST₁₂₀ indicates a test scaled to 120 W/kg.

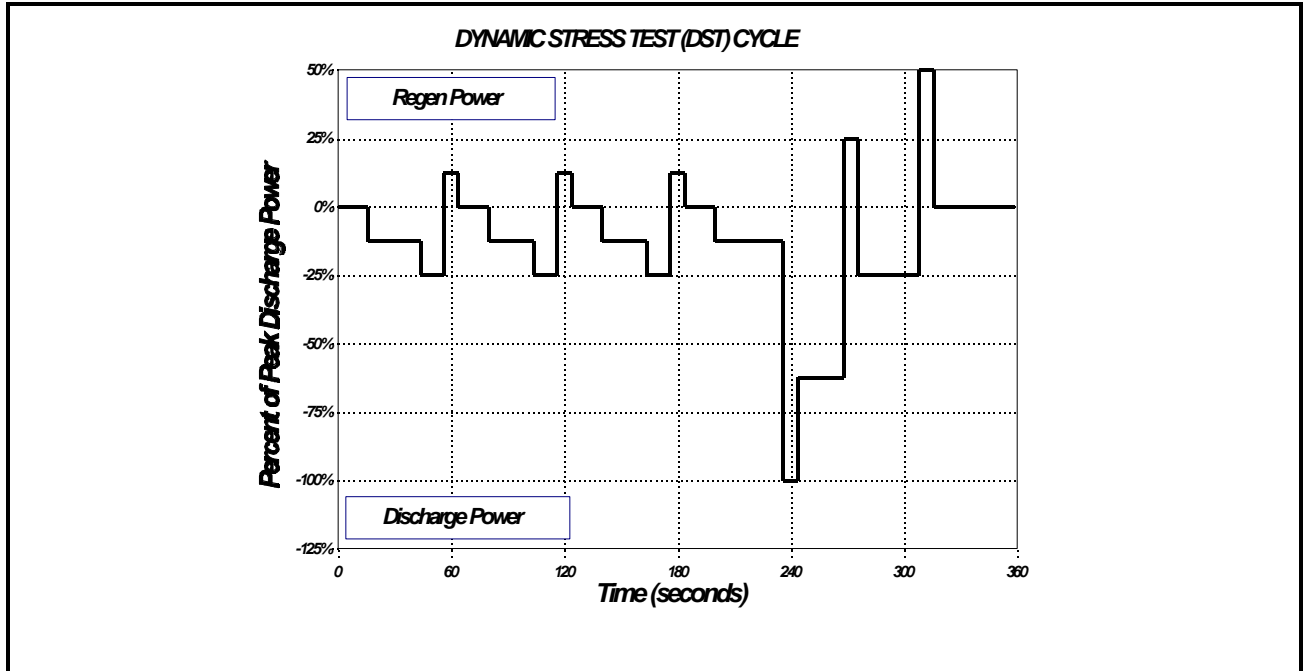

Figure 5B-1. DST Power Profile

Step No.	Duration (seconds)	Discharge Power (%)		Step No.	Duration (seconds)	Discharge Power (%)
1	16	0		11	12	-25
2	28	-12.5		12	8	+12.5
3	12	-25		13	16	0
4	8	+12.5		14	36	-12.5
5	16	0		15	8	-100
6	24	-12.5		16	24	-62.5
7	12	-25		17	8	+25
8	8	+12.5		18	32	-25
9	16	0		19	8	+50
10	24	-12.5		20	44	0

Table 5B-1. Listing of DST Power Profile

**SPECIAL PERFORMANCE TESTS
(Overview)**

Purpose:

Special tests are defined for certain environments and/or conditions that are either (a) likely to be infrequently encountered (outside the normal operating parameters), or (b) only relevant to specific battery technologies. This category may later also include some miscellaneous tests that have not yet been completely defined or for which the rationale is still under discussion.

Abstract:

The special tests that have been defined to date are listed below. The number refers to the applicable Summary Procedure for each.

6. Partial Discharge
7. Stand (self discharge)
8. Sustained Hill Climb
9. Thermal Performance
10. Vibration
11. Charge Optimization
12. Fast Charge

Data Acquisition and Reporting Requirements:

Refer to the appropriate individual Procedure Summary (#6 to #12).

PARTIAL DISCHARGE TEST

Purpose:

The purpose of this test is to measure the response of the battery to a series of partial discharges, identify any resulting capacity loss, and verify proper charging with partial depth-of-discharge (DOD) operation.

Abstract:

The battery is discharged at the manufacturer's specified $C_3/3$ discharge rate for three consecutive cycles, using a 100% DOD cutoff criterion supplied by the manufacturer and the established recharge procedure, to establish its present deliverable capacity (in Ah). The battery is then discharged at the $C_3/3$ rate to a partial DOD level specified in the test plan (default 50%) that is based on the 3-h rate capacity previously determined. Following each partial discharge, the battery is charged in accordance with the battery manufacturer's recommended procedure. In the absence of a recommended procedure, the same procedure and recharge factor used to determine the 100% DOD, 3-h rate capacity is used with the partial discharges. The partial discharge and recharge will be separated by one hour at both the end of discharge and charge, respectively.

Ten of these partial discharge cycles (or a number specified in the test plan) are performed. Following the partial discharge cycles, the 100% DOD, 3-h rate capacity is again measured for at least three consecutive cycles. Additional cycles may be applied as necessary to determine the number required to restore battery capacity to within 1% of the previous level or to a new plateau. To verify that the battery achieved 100% state-of-charge following each partial discharge, the battery current and voltage waveform data are examined to determine the end-of-discharge and end-of-charge voltages. The available 100% DOD capacity after partial discharge operation is examined to identify possible memory effects.

Data Acquisition and Reporting Requirements:

The general requirements are given in Section 4 of Appendix B, Reporting and Data Acquisition Outline. In this test, adequate battery temperature, voltage, and current measurements are to be made as a function of time to allow analyses of the charge procedure with partial discharge operation to determine battery state-of-charge. Specific data reporting is to include a summary that assesses the adequacy of the charge method and effects on available 100% DOD capacity of partial discharge operation along with the number of cycles required for the capacity to recover. In addition, two plots will be provided to support the conclusions (1) the end-of-charge and -discharge voltages versus test cycles, and (2) battery capacity at the end of the partial discharge series of cycles versus 100% DOD cycles (capacity normalized to that obtained before the partial discharge cycles).

STAND TEST

Purpose:

The purpose of this test is to measure battery capacity loss when the battery is not used for an extended period of time, analogous to the situation that occurs when a vehicle is not driven for such a period and the battery is not placed on charge. This loss, if it occurs, may be due to self-discharge, which is normally temporary, or to other mechanisms that could produce permanent or semi-permanent loss of capacity. If significant stand loss is measured, additional testing may be required to determine the cause of this behavior.

Abstract:

Charge the battery in accordance with the established procedure and then discharge it at a constant current $C/3$ rate to 100% DOD, using a 100% DOD cutoff criterion supplied by the manufacturer. This discharge establishes the current 100% deliverable capacity in Ah. Recharge the battery and let it stand for the period specified in the Test Plan (nominally 2 days for midterm and 30 days for long term batteries) in an open circuit condition at ambient temperature or at the normal operating temperature. At the end of the stand period, discharge the battery at the $C/3$ rate to the same cutoff criterion. The difference in the capacity measured at the beginning and end of the stand period is the stand loss.

If stand loss is significantly higher or lower than expected, it may be desirable to adjust the stand period to a different value to obtain a meaningful test. A measured loss of less than 5% may not be statistically distinguishable because of the uncertainty in the measurement. If the measured stand loss exceeds 10%, additional tests should be conducted at high and/or low ambient temperatures (nominally -30°C and $+65^{\circ}\text{C}$ for mid term batteries).

For batteries that use significant energy during standby conditions (e.g. high temperature batteries), the stand loss test is also an appropriate time to measure the operating or parasitic losses associated with such batteries.

Data Acquisition and Reporting Requirements:

The general requirements are given in Section 4 of Appendix B, Reporting and Data Acquisition Outline. The specific data to be reported is to include the capacity loss as a percentage of the measured capacity versus the stand time over which the test was conducted, the baseline A·h removed, and the A·h lost during the stand period.

SUSTAINED HILL-CLIMBING POWER TEST

Purpose:

The purpose of this test sequence is to determine the maximum depth of discharge at which a battery will support a six-minute discharge at about 45 W/kg before it is completely discharged. These measurements are accomplished through a series of specially defined constant power discharge tests. The constant power level of 45 W/kg is approximately that required for the ETV-1 vehicle to negotiate a 7% grade at 30 mph.

Abstract:

During this sequence the test unit will be discharged 3 times from a fully charged state. Each discharge consists of a constant current C/3 discharge to one of 3 specified depths of discharge, followed by a constant power discharge at 45 W/kg to 100% DOD or any other discharge termination criteria (e.g., working voltage, high temperature). The three specified DOD levels are nominally 40, 60 and 80%.

For each discharge, the time for which the 45 W/kg power can be sustained is plotted; this allows a graphical determination of the maximum DOD at which this power can be provided for 6 minutes before the battery is fully discharged.

Data Acquisition and Reporting Requirements:

The general requirements are given in Section 4 of Appendix B, Reporting and Data Acquisition Outline. The specific output of this test is a plot of time at 45 W/kg vs DOD.

THERMAL PERFORMANCE TEST

Purpose:

The purpose of this test sequence is to characterize the effects of ambient temperature variation on battery performance. The characteristics of the battery that are affected are likely to be technology specific. Consequently, the number and types of discharge/charge cycles to be performed cannot be generalized. This procedure is generally applicable to ambient temperature batteries; it may not be applicable to battery systems incorporating thermal management, unless it is desired to measure the effectiveness or energy use of the thermal management system itself. The procedure can also produce results that can be used to determine the need for thermal management or the allowable operating temperature range for a battery that may later incorporate thermal management.

Abstract:

Perform a series of discharge/charge tests where the battery has been allowed to soak (i.e. until the battery internal temperature stabilizes) at a higher or lower than normal operating temperature prior to discharge. The discharges may be specified as constant current (C/3), constant power, or variable power (FUDS or DST) depending on the performance limiting parameters of interest. Suggested temperatures for this test series are -30°C, 0°C, ambient (~23°C) and 65°C for ambient temperature batteries.

If charging performance (such as charge acceptance) under high or low temperatures is a concern, battery recharging may also take place at these temperatures; otherwise the battery can be returned to nominal temperature before being recharged.

Data Acquisition and Reporting Requirements:

The general requirements are given in Section 4 of Appendix B, Reporting and Data Acquisition Outline. The requirements for the specific type of discharge regime being used should be followed. In addition, the number and type of temperature measurements to be acquired will be battery-specific and thus included in the test plan. The obtained temperature data should be reported graphically as a function of time for both the discharge and charge portions of the cycle. If an active thermal management system is included as part of the unit, its power consumption is to be monitored and reported under both charge, discharge and stand conditions, as appropriate.

BATTERY VIBRATION TEST

Purpose:

To characterize the effect of long-term, road-induced vibration and shock on the performance and service life of candidate batteries. The intent is to either qualify the vibration durability of the battery or identify design deficiencies that must be corrected. For testing efficiency, a time-compressed vibration regime is specified, using either sine wave or random vibration. Random vibration is preferred, although it may require more test time and more sophisticated equipment.

Abstract:

The following procedure has been synthesized from actual rough-road measurements at locations appropriate for mounting of traction batteries in electric vehicles. The data were analyzed to determine the cumulative number of occurrences of shock pulses at any given G-level over the life of the vehicle. The envelopes shown in Figure 10-1 correspond to approximately 100,000 miles of usage at the 90th percentile. The procedure is suitable for implementation on a single-axis shaker table, with time-compression to allow completion of the test in just over 24 hours of exposure per test article (for swept sine wave excitation) or approximately 54 hours of testing (for random excitation, if a two-axis table is used.) An alternative random vibration test is also provided to shorten this testing to as little as 24 hours. Both the sine wave and random spectra are based on attempting to match the cumulative vibration events in Figure 10-1.

A complete design verification test shall include at least one, preferably two, batteries that are exposed to one of the following environments early in life, nominally at the indicated states-of-charge (SOC):

Random Excitation:

The test articles should be exposed to vibration in all 3 axial directions for the magnitudes and times shown in Table 10-1 following, where the vibration spectra shown in this table are defined by Figure 10-2. A single axis shaker table can be used (provided that the test article is permitted to be turned on its side or end for testing), and the cumulative times in the table only apply to such use. However, the longitudinal and lateral axis vibration can easily be combined on a two-axis shaker table (or all three groups on a three-axis table) in order to shorten the duration of the testing. Either the normal or alternative test regimes from Table 10-1 may be selected, or these may be mixed in any combination of groups for the vertical and longitudinal/lateral modes.

The recommended states of charge for random vibration testing are nominally 0%, 40% and 80% DOD (the same as for swept sine wave excitation.) See the detailed procedure in Appendix J for more information about the intended variation in state of charge during this testing.

Swept Sine Wave Excitation:

1. VERTICAL AXIS (First Half) (SOC = 100%)
 - (a) 2000 sinusoidal cycles at 5 Gs peak acceleration, applied at the vehicle resonant frequency, to be specified by USABC within the range from 10 Hz to 30 Hz.
 - (b) 60 sine sweeps from 10 Hz up to 190 Hz and return to 10 Hz, to be conducted at a sweep rate of 1 Hz/s for a total duration of 6 hours. The following profile of G-level shall be used:

<u>Frequency Range (Hz)</u>	<u>Peak Acceleration (G)</u>
10 - 20	3.0
20 - 40	2.0
40 - 90	1.5
90 - 140	1.0
140 - 190	0.75

2. LONGITUDINAL AXIS (SOC = 60%)
 - (a) 4000 sinusoidal cycles at 3.5 Gs peak acceleration, applied at the vehicle resonant frequency, to be specified by USABC within the range from 10 Hz to 30 Hz.
 - (b) 60 sine sweeps from 10 Hz up to 190 Hz and return to 10 Hz, to be conducted at a sweep rate of 1 Hz/s for a total duration of 6 hours. The following profile of G-level shall be used:

<u>Frequency Range (Hz)</u>	<u>Peak Acceleration (G)</u>
10 - 15	2.5
15 - 30	1.75
30 - 60	1.25
60 - 110	1.0
110 - 190	0.75

3. LATERAL AXIS (SOC = 60%)

The two regimes specified above for the longitudinal axis shall be repeated for the lateral axis of the battery, assumed to be orthogonal to the longitudinal axis.

4. VERTICAL AXIS (Second Half) (SOC = 20%)

The two regimes specified above for the vertical axis (first half) shall be repeated again in the vertical axis (second half) to complete the sequence of vibration regimes imposed on the battery.

The indicated states-of-charge for either vibration regime should be reviewed and adjusted for each specific battery technology to assure that a worst-case SOC is used.

Two comparisons shall be made to verify the adequacy of the battery design to withstand these vibration regimes. First, the battery(s) under test shall be tested electrically before and after (not necessarily during) exposure to the vibration regimes. There shall be no significant differences in battery performance, as measured using the Reference Performance Test procedures specified in Procedure #14C of this document. Second, the battery(s) shall be tested electrically under a lifetest regime specified in Procedure #14 of this document. There shall be no significant differences in battery performance over life, as compared to batteries undergoing life testing that have not been exposed to the vibration regimes. If desired by the battery developer, the vibration regimes specified above may be repeated to the point of battery failure to establish structural design margins. Such testing should include Reference Performance Tests at appropriate intervals. Supporting tests may include low-level sine sweeps to identify battery resonant frequencies. Battery designers should avoid/suppress any resonant frequency in the range of possible vehicle resonant frequencies (i.e., from 10 to 30 Hz). Battery resonant frequencies above 30 Hz should be sufficiently damped to preclude failure over the life of the battery.

Safety Considerations for Testing

The battery shall be instrumented during the application of the vibration regimes to determine the presence of any of the following failure conditions:

1. Loss of electrical isolation between the battery high-voltage circuit and the (simulated) vehicle chassis/battery case. The degree of isolation shall be verified regularly, e.g. daily, during any period of vibration testing to be within the USABC trial criterion of 0.5 M Ω or greater isolation (1.0 mA or less leakage at 500V DC).
2. Abnormal battery voltages, indicating the presence of open- or short-circuit conditions.
3. Unexpected resonance conditions within the battery, indicating failure of mechanical tie-down components.
4. If applicable, any abnormal temperature conditions, possibly indicating damage to battery cells or thermal management system components.

Testing shall be terminated if any incurred component degradation threatens safe operation of the battery in accordance with the manufacturer's instructions.

Data Acquisition and Reporting Requirements:

In addition to the reporting requirements specified in Appendix B, this report is to include the actual vibration regimes applied, a compilation and interpretation of all data acquired, any results of detailed component failure analyses, and any recommendations for improvements in battery design, installation procedures, or test methods. Also, the pre- and post-vibration electrical performance data that confirms the adequacy of the battery design to withstand the vibration environments shall be summarized.

CUMULATIVE EXPOSURE TO VIBRATION

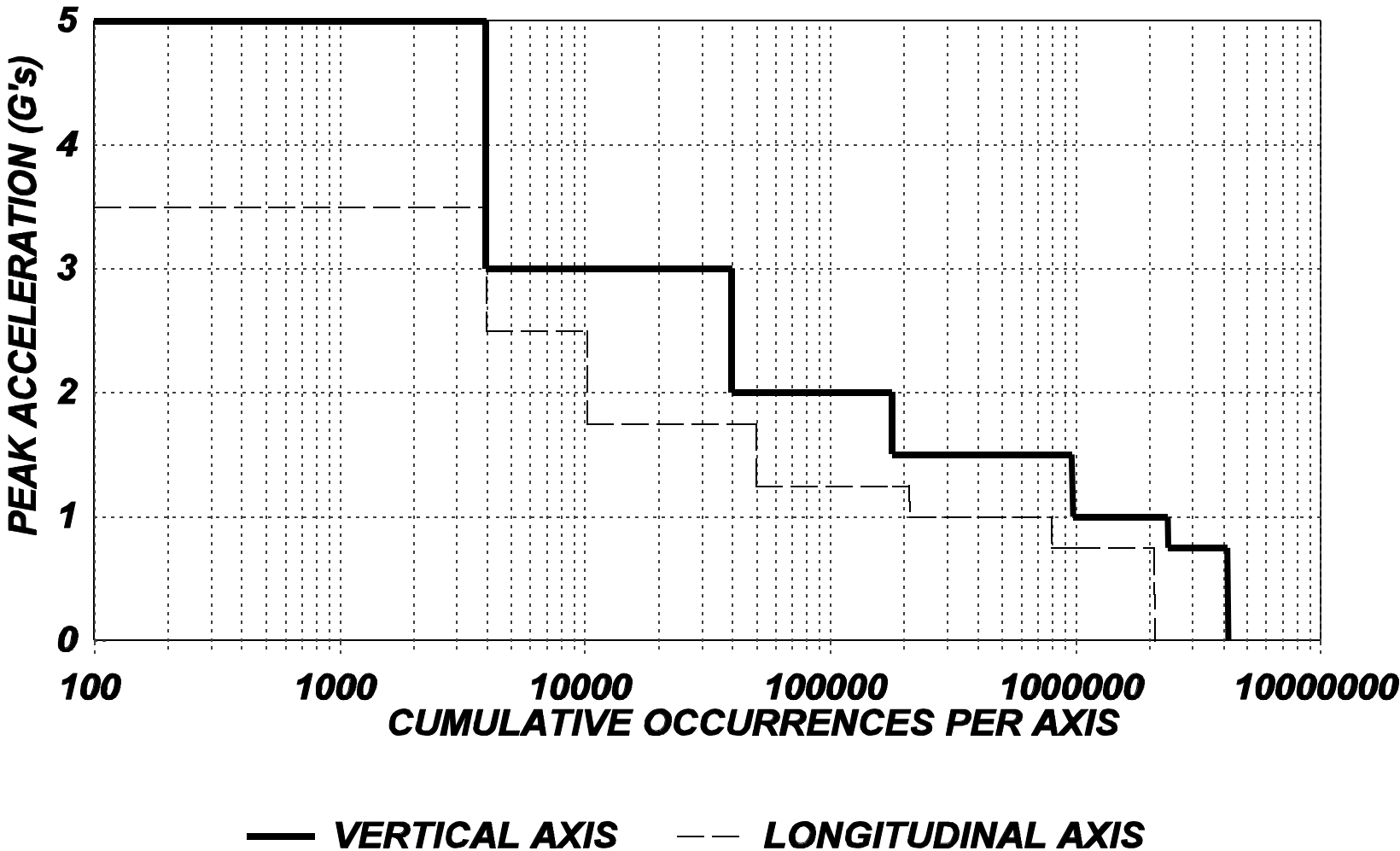

Figure 10-1. Cumulative Vibration Occurrences Corresponding to 100,000 miles of Driving

TEST CONDITIONS		NORMAL TEST			ALTERNATIVE TEST		
VIBRATION SPECTRUM	SOC (%)	Accel (g rms)	Time (h)	Cumul Time, h	Accel (g rms)	Time (h)	Cumul Time, h
Vertical Axis Vibration:							
Vertical 1 spectrum	100	1.9	0.15	0.15	1.9	0.15	0.15
Vertical 1 spectrum	100	0.75	5.25	5.4	0.95	3.5	3.65
Vertical 2 spectrum	100	1.9	0.15	5.55	1.9	0.15	3.8
Vertical 2 spectrum	100	0.75	5.25	10.8	0.95	3.5	7.3
Vertical 3 spectrum	20	1.9	0.15	10.95	1.9	0.15	7.45
Vertical 3 spectrum	20	0.75	5.25	16.2	0.95	3.5	10.95
Longitudinal Axis Vibration:							
Longitudinal spectrum	60	1.5	0.09	16.29	1.5	0.09	11.04
Longitudinal spectrum	60	0.4	19.0	35.29	0.75	6.7	17.74
Longitudinal spectrum	60	1.5	0.09	35.38	1.5	0.09	17.83
Longitudinal spectrum	60	0.4	19.0	54.38	0.75	6.7	24.53
Lateral Axis Vibration:							
Longitudinal spectrum	60	1.5	0.09	54.47 ¹	1.5	0.09	24.62 ¹
Longitudinal spectrum	60	0.4	19.0	73.47 ¹	0.75	6.7	31.32 ¹
Longitudinal spectrum	60	1.5	0.09	73.56 ¹	1.5	0.09	31.41 ¹
Longitudinal spectrum	60	0.4	19.0	92.56 ¹	0.75	6.7	38.11 ¹

Note 1: These cumulative times apply only if all three axes are done separately.

Table 10-1. Vibration Schedule for Random Vibration Test

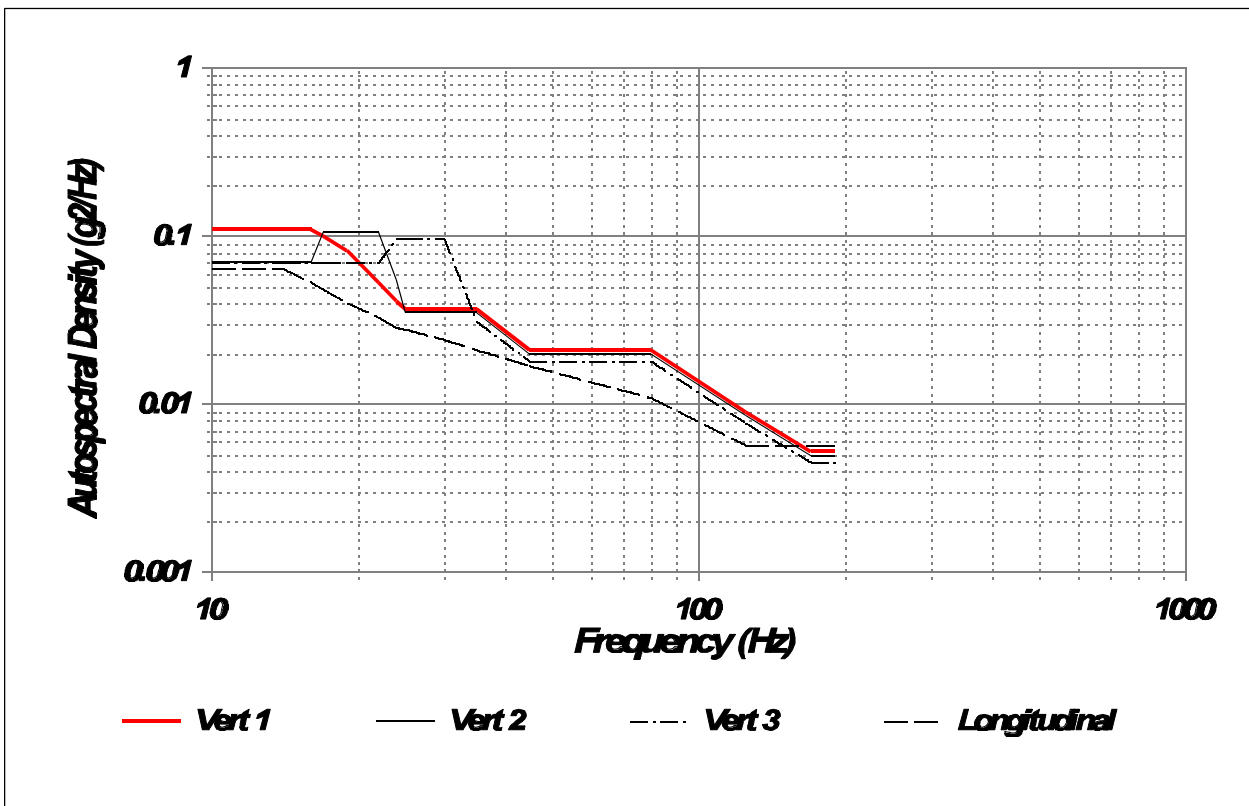

Figure 10-2. Vibration Spectra for Random Vibration Test

CHARGE OPTIMIZATION TESTING

Purpose:

If initial characterization testing indicates that the charge algorithm supplied by the battery manufacturer or developer does not adequately charge the battery, or if a stable battery capacity is not obtained and the charging method is a contributor to this problem, or in the unusual event that a manufacturer's charge algorithm is not available before the start of testing, this procedure can be used to identify or optimize the charge method for use in subsequent procedures.

Abstract:

Charge optimization is a special testing activity that is not normally performed by an independent laboratory. The advice and assistance of the battery developer or manufacturer is necessary to successfully complete this activity. Consequently, a general procedure is not appropriate. A reasonable first approach would be to perform a repetitive sequence of discharge/charge cycles (probably constant current discharges) after each adjustment of the charging algorithm; this sequence would be of sufficient length (10 or more cycles) to establish that the expected capacity or stability had been obtained.

Data Acquisition and Reporting Requirements:

The general requirements are given in Section 4 of Appendix B, Reporting and Data Acquisition Outline. A separate report on the recommended charging method and the results achieved is to be filed and approved for use by the appropriate USABC Program Manager.

FAST CHARGE TEST

Purpose:

The purpose of this test is to determine the fast charging capability of a battery (where appropriate) by subjecting it to high charging rates and determining the efficiency and other effects of such accelerated charging. The USABC goal for fast charging (for batteries capable of such usage) is to return 40% of the state of charge of the battery, starting from approximately 60% DOD, in 15 minutes (i.e. increase from 60% to 20% DOD, or 40% to 80% state-of-charge), although few batteries are expected to be capable of being recharged at this rate.

Abstract:

This test will normally be conducted as a series of cycles at a progression of fast charge rates, beginning at approximately twice the normal (overnight) rate. For each charge rate, the following sequence of steps is performed:

1. After fully recharging the battery, discharge it to 60% DOD at a C/3 constant current discharge rate (based on previous test data).
2. Immediately recharge the battery at the selected charge rate until 40% of the rated capacity (in Ah) has been returned.
3. Immediately fully discharge the battery at a C/3 rate to determine the amount of the recharge available for use.

The test series terminates when (a) the 40% capacity in 15 minute charge rate is achieved; or (b) the battery temperature, voltage, or other operating limit is exceeded during recharge.

Data Acquisition and Reporting Requirements:

The general requirements are given in Section 4 of Appendix B, Reporting and Data Acquisition Outline. Specific data deliverables include plots of voltage and temperature vs time during cycle; percent of effective charge return as a function of fast charge rate.

**SAFETY AND ABUSE TESTING
(Under Development)**

Purpose:

This set of tests is performed to characterize the response of integrated battery systems to expected and worst-case accident and abuse situations. The information gained from this testing will be used to qualify their safe operation and to identify design deficiencies. Tests that address conditions associated with government regulations or expected accident-related exposures are included in the "safety" category. "Abuse" testing involves the characterization of the battery response to "worse-case" accident and unintentional abuse conditions and is ultimately performed to provide public confidence that these systems are indeed safe. Conditions to be investigated include those associated with possible vehicle crashes, exposure to external environments, and electrical charger malfunction. Certainly some overlap will exist between tests appropriate for the safety and the abuse categories.

Abstract:

The general types of test procedures listed below are to be performed on full-size batteries or representative modules with all ancillary components that are integral to the battery pack installed (e.g., battery controller if attached, mechanical support, thermal enclosure). Batteries are to first be conditioned with a low number (e.g., 50) of complete electrical cycles using a life-cycle test regime (Procedure 14). Safety and abuse testing is to proceed only if the battery shows typical operating characteristics, as determined by the manufacturer. Each battery is to be fully charged and placed in a support frame or pannier that is consistent with using that battery in a generic electric vehicle. At least one fully functional battery pack (preferably replicated) is to be subjected to each of the selected procedures. For selected abuse testing only, any internal electrical safety devices can be bypassed.

NOTE: The actual test procedures must be selected by the appropriate USABC program manager based on a number of criteria (e.g., technical, legal) that at present have not been fully defined. The definition of draft procedures is currently being completed in which all publicly available vehicle accident data is being considered in conjunction with an analytical risk assessment.

Safety:

- Specific procedures are being defined that are (1) based on existing or planned Federal Motor Vehicle Safety Standards (FMVSS) for electric vehicles; or (2) associated with accident situations or environmental exposures that have a reasonable probability of occurring. Focus is being directed to on-road vehicle use.

Abuse:

- Mechanical
- Environmental Exposure
- Electrical

Data Acquisition and Reporting Requirements:

The general requirements are given in Section 4 of Appendix B, Reporting and Data Acquisition Outline. The requirements for the specific type of test being performed will be defined in the test plan. However, in general, data is to be gathered for 2 hours following the initiation of each safety/abuse test. The frequency of data acquisition depends on the specific test procedure, but typically must be less than 1 minute. The electrical performance data obtained during the conditioning cycles must be consistent with the reporting requirements for the life-cycle test procedure. Specific data acquisition for the abuse tests is to include: (1) battery voltage; (2) physical response (dimensional change, weight change, degree of fragmentation, existence of fire, breaching of containment); (3) release of liquid (molten) and gaseous products (quantity, composition, and rate); (4) thermal response on and near the battery; and (5) video and audio recording of the entire event.

The additional reporting requirements include the a completed description of the actual test procedure used, and a compilation and interpretation of all acquired data. A complete battery failure analysis is to be performed and documented. A copy of the video recording of each event must be submitted. Finally, any difficulties encountered with the battery or the test procedure are to be noted.

LIFE CYCLE TESTING (GENERAL)

Purpose:

This test summary defines a set of standardized procedures to determine if the expected service life (calendar and cycle) of electric vehicle batteries will satisfy USABC requirements. Both accelerated aging and normal-use conditions are employed to efficiently characterize degradation in electrical performance as a function of life and to identify relevant failure mechanisms. Because the intent is to use standard testing conditions whenever possible, results from the evaluation of different technologies should be comparable. These procedures may need to be repeated as design or material changes occur during the development process. Characterization of safety-related performance is not included in this procedure (refer to Procedure #13).

Test units may be cells, modules, or complete battery packs. Failure statistics are desired at the lowest possible level, such that confidence in the statistical life parameters is maximized. For most technologies, it is possible to project battery life from cell or module data, particularly when these data have been obtained from pack testing using realistic battery controls. After careful audits of test procedures and data, the USABC may merge comparable life data from the developer with data obtained from tests under its direct supervision. Analysis to project battery life from test data must be tailored to specific technologies and pack designs.

Abstract:

A critical first step in this procedure is the definition of a clear test objective that ultimately must be consistent with the number of available test units. Three primary options exist: (i) independent verification of developer information, (ii) experimental identification of accelerated aging parameters, or (iii) collection of statistically significant data for ultimate life estimation. This last objective must normally be satisfied in close cooperation with the developer to maximize the number of units evaluated according to the USABC testing protocol.

A diagram of the processes to be completed during life-cycle testing is shown in Figure 14-1. For a specific test unit, the general life-cycle test sequence consists of the following: (a) select an applicable aging regime, (b) repetitively apply the selected regime for a specified interval (e.g. 28 days), (c) conduct a series of reference baseline cycles, and (d) repeat steps (b) and (c) until the specified end-of-test (EOT) conditions are reached.

The available test units are to be subjected to either accelerated-aging or actual-use life-cycle test regimes. Separate sub-procedures are included for each of these options: accelerated aging (#14A) and actual use (#14B). Baseline testing (#14D) is defined as a special case of accelerated aging. Based on the status of the technology and the overall objective, a decision must be made by the program manager concerning this allocation. Those units to be subjected to an actual-use simulation must be started as soon as possible. However, to ensure these long-term tests will be useful, confidence must exist that the development of the product is reaching completion. Thus, in general, because of the lack of available time and the changing nature of the candidate technologies, a relatively low percentage of the life-cycle testing should be performed with the actual-use regime.

Data Acquisition and Reporting Requirements:

Refer to the applicable individual Procedure Summary (#14A and #14B).

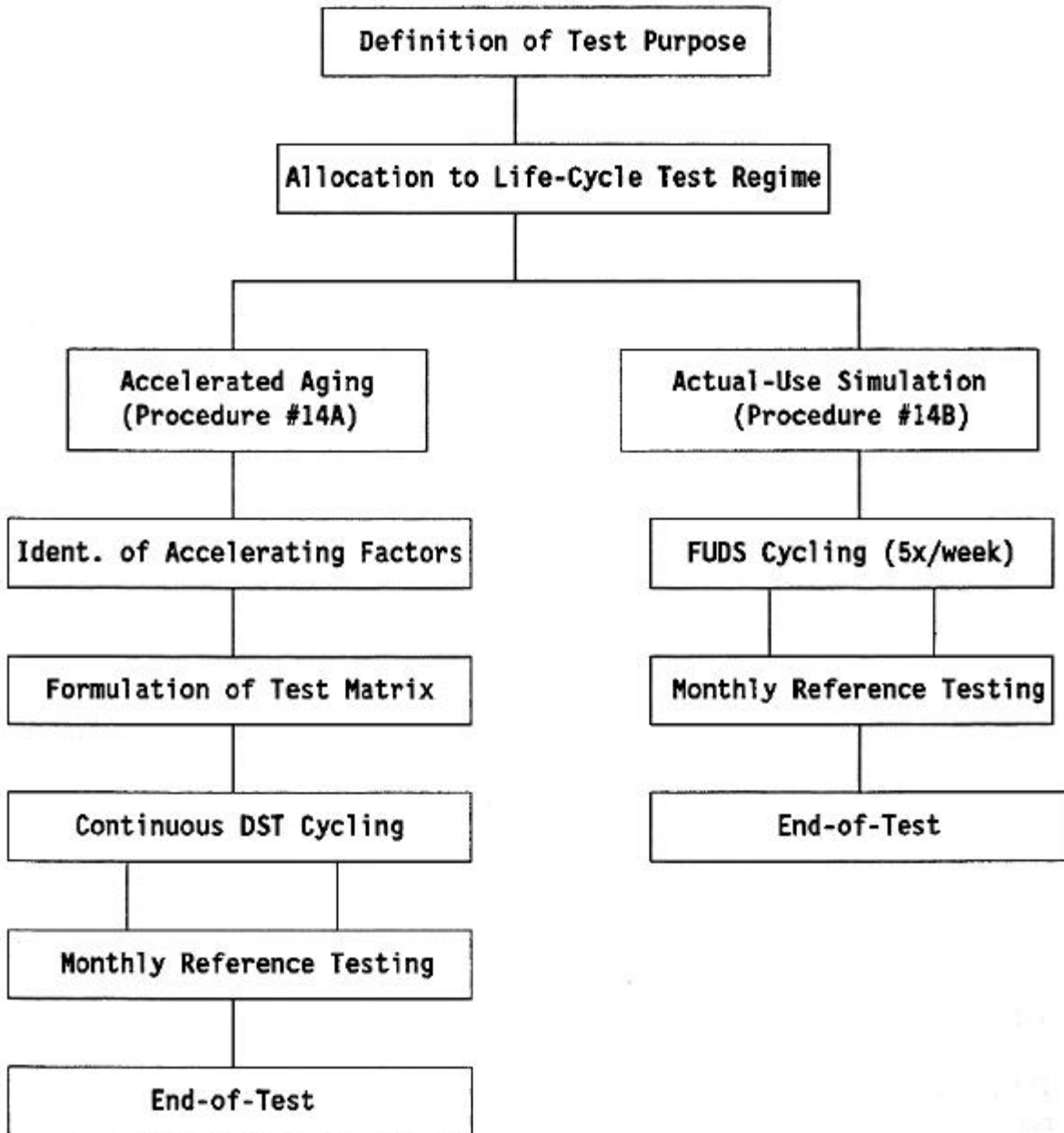

Figure 14-1. Steps within Life-Cycle Test Procedure

ACCELERATED AGING TESTING

Purpose:

This procedure contains a series of steps that are to be followed to accelerate the aging of candidate battery test units. This procedure focuses on "overstress" testing: the application of stressful parameters that are related to normal use and reduce life or quicken degradation. Thus, accident or abuse situations are not considered. Time compression (i.e., continuous electrical cycling) is required as a common aspect within this procedure. For most technologies, this higher than normal cycling rate should not produce a different mode of failure. To help ensure some applicability to electric vehicle use, the baseline cycling regime (Procedure 14D) is the DST performed to 80% of rated capacity.

The objective is to accelerate relevant failure modes and degradation mechanisms to permit reasonably precise aging factors (accelerated life to real life) to be determined. Satisfaction of this objective requires phenomenological correlations to normal-use service life to be made that are based on engineering knowledge and experience. An undesirable, although sometimes unavoidable, outcome is that only empirical correlations are possible. In this latter situation, only improvements in specific components can be assessed. The extreme difficulty involved with defining effective accelerated aging approaches for these complex electrochemical systems is acknowledged. Nevertheless, this procedure has been developed as a guideline to facilitate cost-effective testing. The implementation of this "standardized" procedure will allow the collection of the maximum amount of data in the shortest possible time, thus allowing performance to be verified when possible. In addition, progress among the various candidate technologies can be compared in a timely manner.

All USABC test planners are strongly urged to gain additional, more detailed, information on accelerated aging. An excellent reference is the following book: Wayne Nelson, *Accelerated Testing*, John Wiley and Sons, 1990. Chapter 1 contains an appropriate overview of this topic.

Abstract:

A flowchart of the specific steps to be performed during the accelerated life-cycle testing was shown in Figure 14-1. A summary of each step follows:

1. Identification of Accelerating Factors: Based on knowledge of the failure modes of the candidate technology, identify those stress factors that can be controlled and that can potentially accelerate aging (e.g., temperature, depth-of-discharge, rate of discharge/recharge). The expected effect of each factor is to be ranked (e.g., high, medium, or low) along with a judgement of if a relevant life-cycle failure mode will be affected. In other words, the goal is not just to make the unit fail quickly, but to enable a true accelerating factor to be determined. The results can be scaled back to actual-use conditions. Finally, with consideration also given to safety-related consequences and known failure levels, the range for each stress factor (minimum to maximum) is to be estimated. The minimum stress-factor level must still represent an accelerated condition. For example, the temperature range for the nickel-metal-hydride technology could be 35 to 55°C.

2. Formulation of Test Matrix: In this step, an efficient experimental matrix is to be formulated. An orthogonal array of tests is the preferred configuration because more than one factor at a time can be evaluated and the results are more reliable. However, several considerations exist that may preclude the need for or ability to perform a full experimental matrix. These include the selected objective, the number of available test units, and/or the inability to control the interaction of some test parameters. In these cases, a classical (i.e. "one factor at a time") configuration may be more appropriate.

For either approach, this step involves analyzing the information obtained in #1 (factors and importance) in conjunction with the number of available units (size of the array), the test objective, and the requirement that three common elements be included in all accelerated life-cycle testing: time compression (continuous, back-to-back electrical cycling), a dynamic discharge regime (DST), and periodic (e.g. monthly) reference benchmarking (RPT). The use of the DST profile must be modified within its definition to accommodate the subject stress factor. In practice, the following four factors can easily be incorporated into the DST profile: temperature, depth-of-discharge, rate of discharge (maximum power level), and recharge profile. Appropriate modifications to the DST profile for other factors that are applicable to specific technologies must be defined. The primary part of this step (the analysis) normally requires the selection and use of a mathematical model to ensure that the information required in the subsequent estimate of life will be obtained.

Many reference books have been written that describe techniques for defining effective orthogonal matrices, including those in the Taguchi Methods. A good example is the following: M.S. Phadke, *Quality Engineering Using Robust Design*, Prentice Hall, New Jersey, 1989. Although these techniques are normally used to optimize variables associated with manufacturing processes, they can be effective in this application. Importantly, an actual-use simulation (#14B) must be performed following this type of testing to verify that any interactions among the control variables were properly modeled.

The construction of classical experimental matrices is described in Chapter 6 of Nelson's book. The goal of each individual test should be to simulate actual use except for the overstress parameter. Therefore, an effort must be made to properly control all test parameters so that only the factor(s) of interest are being varied. For example, in a high-rate recharge, active thermal management may be required to control any temperature increase.

Optimized classical test matrices include life evaluations only at the maximum and minimum in the allowable range of each stress factor (determined in Step 1). Intermediate levels are not desired. However, this type of configuration can only be specified if the planner is reasonably certain that a single relevant failure mode will be dominant across the range. If uncertainty exists, then an intermediate point is needed to verify or determine if the failure mode does change. Prudent engineering judgement needs to be applied. In any case, emphasis during the allocation process should be placed on the maximum values when the available test time is at a premium and/or relatively accurate results are not needed. Conversely, the best accuracy is obtained when more units are allocated to the minimum stress level (closer to actual use).

Thus, as the technology development process matures, more of the units should be tested using lower-stress conditions.

3. Performance of Test Plan: The experimental matrix defined in Step 2 should be randomized with respect to test location, initiation order, and the various test parameters to reduce unknown or uncontrollable effects from noise factors. The specific steps to be followed during each test are as follows:
 - (a) Apply the selected 360-sec DST discharge segment "end-to-end" with no wait period between each segment, to the specified depth-of-discharge (80% of rated capacity for the baseline case) or until another manufacturer-specified constraint has been reached (e.g., voltage or thermal limit). The maximum DST power level is to be determined either as part of Step 2 or as recommended in Procedure 5B. Within any thermal limits, recharging is to be immediately performed.
 - (b) At appropriate intervals, the continuous DST cycling is to be halted and a set of Reference Performance Tests (RPT) performed. (See Procedure 14C.)
 - (c) Repeat Steps 3a and 3b until an end-of-test condition, as defined in the specific test plan, is reached. Normally, the end-of-test criteria for battery-level test units should be at higher states of degradation than correspond to the USABC end-of-life definition (<80% of rated capacity or peak power, see Appendix F) to enable more failure information to be obtained. However, battery cycle life is reported only to end-of-life conditions; cycles performed after end-of-life is reached must be counted separately.

Data Acquisition and Reporting Requirements:

The general requirements are given in Section 5 of Appendix B, Reporting and Data Acquisition Outline. The specific reporting requirements of this test include a historical record tabulating test summary information and testing anomalies. This information is to include cycle number, type of regime, duration, energy, gross and net Ah removed, energy efficiency, EOC and EOD open-circuit voltage, initial and final temperature, and EOD resistance. The actual reported cycle life of a particular test unit (at the reported test conditions) shall include (count) the following:

- any performance tests performed prior to the start of life cycle testing which discharge the battery to 80% DOD or greater
- All Reference Performance Tests up to but not including the final RPTs which establish that end-of-life has been reached
- All repetitive discharge tests for which the specified capacity (e.g. 80% of the rated capacity in net ampere-hours for baseline testing) is achieved, i.e., any additional tests performed after either the specified capacity is not reached or end-of-life is verified shall not be included in the cycle life count

Data Analysis:

The generic steps that are to be performed during the analysis of the data obtained during the life-cycle testing are summarized in the following list. Although this activity is not a required part of this procedure, its use during Steps #1 and #2 is recommended to ensure that an effective plan is produced.

1. Identify the smallest unit (e.g., cell, string, module) for which failure information was obtained and assemble a database containing service-life statistics.
2. Select/develop appropriate mathematical models (e.g., Arrhenius) that describe the primary effects of the accelerating factors on life. Then, perform an analysis of the data (e.g., ANOVA) to determine the relative influence of and correlation each factor.
3. Characterize the service-life characteristics of the subject smallest unit for actual-use conditions with a statistical distribution (e.g., Weibull, log-normal). The distribution must account for the variability and uncertainty in the life data.
4. Use a mathematical routine that considers the candidate battery configurations and the relationship identified in the previous step to estimate actual battery life. This activity normally requires the use of a "Monte Carlo" type simulation.

ACTUAL USE SIMULATION TEST INCLUDING AMBIENT TEMPERATURE INFLUENCE

Purpose:

This test regime is used to reasonably simulate the conditions that an electric vehicle battery may experience in actual operation. Results from these tests will eventually validate the accelerated life-cycle testing performed under Procedure #14A. This testing requires the test battery to be discharged using a FUDS power profile (#5A). It also provides for exposing the battery to a wide range of ambient temperatures to account for a expected range of seasonal and geographic variability in customer environments.

Abstract:

The procedure is outlined as follows:

1. The test unit is to be subjected to one FUDS-based discharge/charge cycle (#5A) per day for 5 days per week, scaled to 80% of the USABC peak power requirement for the technology (or 80% of the battery's peak power rating, whichever is larger.) The battery should be subjected to ambient temperature variations during testing as described in the following section.
2. For each discharge, apply the 1372-second FUDS regime "end-to-end" with no wait period between each segment, to a depth-of-discharge of 80% of rated capacity in net ampere-hours or until another manufacturer-specified constraint has been reached (e.g., voltage or thermal limit). Within any thermal limits, recharging is to be immediately performed.
3. At appropriate intervals (or as specified in the test plan), the continuous FUDS cycling is to be halted and a set of Reference Performance Tests performed, as specified in Procedure 14C. RPTs are always performed at normal ambient temperature, regardless of the temperature regime in use for cycling. For testing efficiency, the temperature regimes to be used (defined below) may be imposed in clusters of cycles (e.g. between RPT repetitions) rather than distributed evenly over the life of the battery.
4. Repeat Steps 1 to 3 until an end-of-test condition specified in the test plan is reached.

Ambient Temperature Test Conditions:

A distribution of ambient temperature conditions has been derived from actual temperature data for two relatively extreme locations: Buffalo, NY and Palm Springs, CA. Figure 14B-1 shows the cumulative fraction of the time (averaged over one or more years) for which the ambient temperature would exceed any given value at each of these locations. Based on this distribution, Table 14B-1 shows the percent of the total life cycles which should be performed in each of 5 temperature ranges; values are given for batteries intended for full-range operation, as well as those intended only for locations where extremes of hot or cold temperatures are not anticipated.

This procedure may be applied in several ways. Applied directly to cells, modules or battery packs, it can characterize the technology life without thermal management controls, for comparison with life measured at the normal ambient temperature. However, because of the mixed nature of the

temperature data resulting, it may not be appropriate to use this procedure as a substitute for thermal performance testing (Procedure #9) for technologies whose performance at various temperatures is not yet known. For complete battery systems or test units with thermal management controls, it can be used as an integrated system test to determine the effectiveness of the thermal management design and project battery life under approximate ‘actual use’ conditions.

Data Acquisition and Reporting Requirements:

The general requirements are given in Section 5 of Appendix B, Reporting and Data Acquisition Outline. Reporting of measured cycle life shall be done according to the conditions specified in Procedure 14A. Because of the integrated nature of this test, interpreting its results will require more information than might be needed for a simpler test regime. Consequently a report shall be provided that contains a detailed description of the battery and test setup, the actual temperature regimes applied, a compilation and interpretation of all performance data acquired, any results of failure analyses, and any recommendations for improvements in battery design, installation procedures, or test methods. The ability to accurately reproduce the test cycle is not required for FUDS life test cycle data, but a cycle-by-cycle summary should be presented in tabular and/or graphical format.

Table 14B-1. Percent of test time to be spent at various temperature ranges

Temperature Range	Full Range Batteries	Hot Climates Only	Cold Climates Only
Cold $T \leq -8^{\circ}\text{C}$	10	-	10
Cool $-8^{\circ} < T < 0^{\circ}\text{C}$	15	-	15
Normal $20^{\circ} \pm 10^{\circ}\text{C}$	50	50	60
Warm $30^{\circ} < T < 38^{\circ}\text{C}$	15	40	15
Hot $T \geq 38^{\circ}\text{C}$	10	10	-

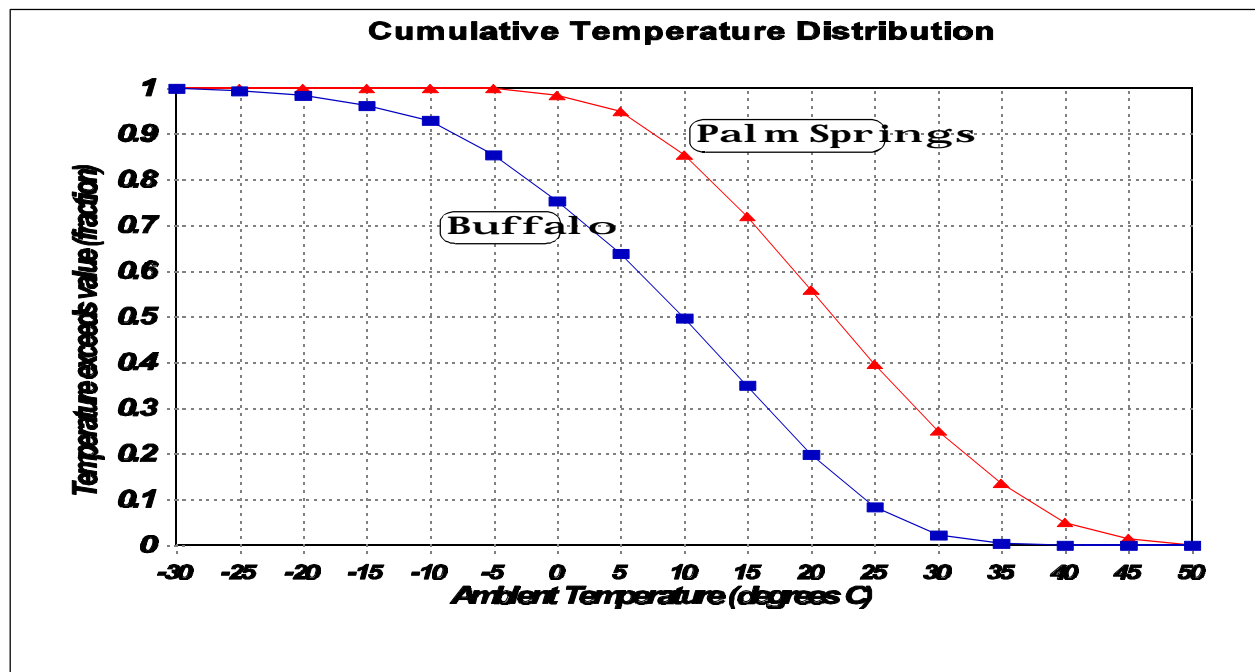

Figure 14B-1. Fraction of the time a given ambient temperature is exceeded at two locations

REFERENCE PERFORMANCE TESTS

Purpose:

This set of tests is used to characterize degradation that occurs during the life of the subject test unit. These baseline cycles consist of a group of electrical performance tests that are repeated periodically during life-cycle testing, permitting various performance and failure characteristics to be compared on a common basis.

Abstract:

This procedure will normally be performed during life-cycle testing of a battery at regular intervals (e.g. every 28 days or 50 cycles) corresponding to 5-10% of the anticipated battery life, unless a particular interval is specified in the test plan. These tests (including the recharges before and after the discharge sequence) are always performed at nominal environmental conditions, even though life-cycle testing may be taking place at off-normal conditions to accelerate battery aging. The test unit (cell, module, or pack) will be charged prior to initiation of this sequence and then temperature stabilized, if needed (as directed in the test plan). Commencing from full charge, the module/battery will be subjected to the following tests in the order specified, conducted according to their respective procedures except for limitations as noted below:

1. Constant Current discharge at C/3 rate (only) to 100% of rated capacity [Procedure #2]
2. DST discharge scaled to 80% of the USABC peak power goal for the technology, to 100% of rated capacity in net ampere-hours [Procedure #5B]
3. Peak Power discharge [Procedure #3]

This sequence of tests will normally be performed once (i.e., 3 cycles total) each time the procedure is performed. The battery will be fully recharged after each discharge.

The rationale for the selected RPT sequence is to (1) return the unit to a reproducible and standard state with the constant current cycle, and (2) use the DST and Peak Power cycles to identify any degradation in available energy or pulse power capability. Determination of end-of-life (not end-of-test) is based on the results of the DST and Peak Power tests. (See Appendix F.)

Data Acquisition and Reporting Requirements:

The general requirements are given in Section 4 of Appendix B, Reporting and Data Acquisition Outline. Specific data requirements are given in the appropriate individual procedures (#2, #3, #5B) as well as the individual life cycle test procedures (#14A, #14B, #14D).

BASELINE LIFE CYCLE TEST**Purpose:**

This test regime is used to determine the battery life achieved under a 'reference' or baseline set of test conditions, for comparison with the results of accelerated life testing under any other set of test conditions. This test procedure may be used for standalone testing or as the baseline case for a program of accelerated aging tests using Procedure 14A. The discharge profile used for this test is the DST (Procedure #5B), normally scaled to 80% of the USABC peak power goal for a technology (i.e. 120 W/kg for midterm battery technologies.) However, if the rated peak power for a battery exceeds the USABC goal, the test should be scaled to 80% of the battery's rated power instead. All discharges (except Reference Performance Tests) are conducted to 80% of rated capacity, provided this can be done without exceeding the Discharge Voltage Limit or other battery limits defined in the test plan.

Note that this test is not intended to project the life of a battery in actual use; Procedure 14B is more suited for such a purpose. In particular, continuous cycling may result in some life impacts because of thermal effects or other mechanisms. However, this test is the most commonly used USABC life cycle test case because of its reference nature, repeatability, and time compression effect.

Abstract:

The specific steps to be followed during each test are as follows:

1. The test unit is to be subjected to continuous cycling using the DST (#5B).
2. For each discharge, apply the 360 second DST regime "end-to-end" with no wait period between each segment, to a depth-of-discharge of 80% of rated capacity in net ampere-hours or until the Discharge Voltage Limit or a manufacturer-specified constraint has been reached (e.g., thermal limit). Within any thermal limits, recharging is to be immediately performed.
3. At appropriate intervals (or as specified in the test plan), the continuous DST cycling is to be halted and a set of Reference Performance Tests performed, as specified in Procedure 14C.
4. Repeat Steps 1 to 3 until the end-of-test condition, as defined in the specific test plan, is reached.

Data Acquisition and Reporting Requirements:

General requirements are given in Section 5 of Appendix B, Reporting and Data Acquisition Outline. Because this test is the baseline case of accelerated life cycle testing, specific reporting requirements are identical to those defined for Procedure 14A. End-of-life is determined according to the definition in Appendix F. Reporting of measured cycle life shall be done according to the conditions specified in Procedure 14A.

APPENDIX A

GENERIC TEST PLAN OUTLINE FOR USABC BATTERY TESTING

USABC TEST PLAN NUMBER _____ Rev. _____
Date

APPROVAL: _____
USABC Program Manager Date

APPROVAL: _____
USABC Test Manager Date

ACKNOWLEDGEMENT: _____
Test Lab Representative Date

GENERIC TEST PLAN OUTLINE FOR USABC BATTERY TESTING

1.0 **Purpose and Applicability**

This test plan defines a series of tests to characterize aspects of the performance or life cycle behavior of a battery for electric vehicle applications. These tests may be applied to single cells, battery modules, full-size battery packs or complete battery systems (all of which are referred to as batteries in this plan). It may also be used to specify testing for multiple identical batteries subjected to the same or different test regimes (see Section 5.0.)

2.0 **References**

(To be as required by manufacturer or USABC Program Manager)

3.0 **Equipment**

Power, voltage, and current capabilities for the electronic loads and power supplies are to be specified. Special test equipment required for the conduct of this test plan (if any) is specified in the individual test procedures.

4.0 **Prerequisites and Pre-Test Preparation**

In addition to any prerequisites defined in individual test procedures, the following actions shall be performed by the testing organization prior to testing a battery under control of this test plan:

- 4.1 The USABC identification number for the battery shall be determined and affixed to the battery (if this has not been done by the manufacturer.) (See Appendix D for numbering system.)
- 4.2 The battery or battery modules shall be examined to determine that damage has not occurred during shipping or handling, and that the type and configuration (e.g. number and interconnection of modules) are correct and agree with the assigned identification number.
- 4.3 The battery's physical dimensions and weight shall be measured. For battery packs containing multiple subunits (modules or cells) interconnected by lab personnel after receipt, the modules will be weighed individually; in other cases, the entire battery may be weighed as a unit to avoid disassembling it (see Appendix E Worksheet).
- 4.4 Actual power levels (kW) and capacities (kW·h or A·h) shall be established for those planned tests specified in Section 7.0 where the procedures do not specify these levels. These values should be derived from the ratings specified in Section 5.0 of this plan, based on the manufacturer's worksheet (Appendix E) and the measured weight or other characteristics of the battery. If these are based on values other than manufacturer's ratings or a fixed percentage of the USABC Mid Term or Long Term goals, the basis shall be noted in the test plan and the battery log and subsequently reported.

5.0 **Ratings, Test Limitations and Other Test Information to be provided**

Battery ID Number _____

NOTE: If more than one battery is covered by this test plan, provide table of ID numbers. If a group of otherwise identical batteries is to be subjected to different sets of performance tests, multiple copies of Tables 7.3 and 7.4 may be used.

Development/Testing Phase _____ (Information only)

5.1 RATINGS (DISCHARGE)

NOTE: All ratings are at Beginning of Life. A worksheet summarizing information to be supplied by the manufacturer for each battery is included as Appendix E.

Rated Capacity _____ (Ah)

Ampere Hour Capacity: 3-hour (C/3) rate _____ (Ah)

2-hour (C/2) rate _____ (Ah)

1-hour (C/1) rate _____ (Ah)

Rated Energy Capacity _____ (kWh at 3-hour C/3 rate)

Test Unit Peak Power (rating at 2/3 OCV and 80% DOD at beginning of life)
_____ (W or kW) (Nominal)

Peak Discharge Power to be applied on DST or FUDS testing
_____ (W or kW)

Maximum Allowable (Peak) Currents to be applied during Reference Performance Cycle or Peak Power Tests:

Discharge _____ (Amperes)

Regen _____ (Amperes)

Percent of capacity at top of charge where regen should not be applied (if applicable)
_____ (%)

5.2 TEST TERMINATION CONDITIONS (applicable to planned tests)

DISCHARGE LIMITATIONS	VALUE	UNITS
Minimum Discharge Voltage		V/cell etc. *
Discharge Temperature Limit(s)		°C
Other (e.g. Max Current etc.)		

* Specify load conditions if rate-sensitive. (If a value less than Discharge Voltage Limit is specified, the DVL will be used for the Peak Power Test. DVL will also be used for DST or FUDS tests unless a specific exemption is included in the test plan.)

END OF LIFE TEST CONDITION(S): _____

5.3 OPERATING TEMPERATURE (Initial and limits for testing)

5.4 CHARGING

Procedure: _____

CHARGE LIMITATIONS	VALUE	UNITS/DEFAULT
Maximum Voltage on Charge		V/cell and/or battery
Maximum Charge Temperature		°C
Maximum Charge Rate		Amperes, watts, time
Open Circuit Time After Charge		(Default 1-24 hrs)

5.5 OTHER INFORMATION (Attachments can be referenced here)

Test laboratory Readiness Review requirements: _____

Thermal enclosure or other battery management system handling instructions (if applicable): _____

Commissioning Instructions: _____

Battery Configuration Description: _____

6.0 **Safety Concerns and Precautions**

(To be included or attached as applicable.) **NOTE: any conditions requiring safety-related monitoring provisions and/or action shall be identified and described here.**

7.0 **Number and Types of Tests to be Performed Under this Test Plan**

7.1 TEST CONTINUATION CRITERIA

Any ratings or required test results that constitute acceptance for testing (i.e. further testing should not be performed unless these criteria are met) should be identified here or noted in the tables. Normally, the capacity of the unit must be no less than 95% of rated, as determined either during

commissioning or the C/3 constant current discharge specified in Section 7.2. _____

7.2 CORE PERFORMANCE TESTS (REQUIRED)

NOTE: Core Performance Tests are to be performed on all test units unless specifically exempted in writing by the USABC Program Manager, in which case the reason for exemption should be documented. If an adequate charge procedure is not furnished or available, Test Procedure #11 from Table 7.4 should be performed prior to initiating the Core Performance Test series.

TEST PROCEDURE	MINIMUM REPS	OTHER INFORMATION
2. Constant Current	3	@ 3-hour discharge rate
3. Peak Power	1	Single discharge
5. Variable Power	1	Default is DST, FUDS optional
4. Constant Power	1	@ Rate required to remove 75% of energy in 1 hour (may be done for only 1 hour)

7.3 GENERAL PERFORMANCE TESTS (OPTIONAL)

TEST PROCEDURE	NO. REQ'D	OTHER INFORMATION
2. Constant Current		Default for procedure is 12 charge/discharge cycles at C/3, C/2, C/1, C/3 discharge rates
4. Constant Power		Default power values are those required to remove 75%, 50%, 25% of battery energy in one hour. (Discharge to rated capacity or termination limits)
5. Variable Power		Regime (FUDS or DST) not performed as part of Core Performance

7.4 SPECIAL PERFORMANCE TESTS (OPTIONAL)

TEST PROCEDURE	NO. REQ'D	OTHER INFORMATION
6. Partial Discharge		Specify partial DOD value (Default 50%)
7. Stand		Specify stand period (default 48 hrs midterm, 30 days long term)
8. Sustained Hill Climb		
9. Thermal Performance		Specify matrix of temperatures & discharge/charge cycles
10. Battery Vibration		Specify random or swept sine wave excitation, normal or accel
11. Charge Optimization		Specify only if charge procedure not furnished in Section 5.4
12. Fast Charge		Specify initial rate (default 2 times normal)

7.5 SAFETY/ABUSE TESTS (under development; following table is only an example)

TEST PROCEDURE	SELECTED BATTERY ID NO.	OTHER INFO
MECHANICAL		
13A. Impact (drop)		
13B. Deformation (bend)		
13C. Intrusion (spike)		
13D. Turnover		
ENVIRONMENTAL EXPOSURE		
13E. Fire		
13F. Immersion		
ELECTRICAL		
13G. Over-Charge		
13H. Short-Circuit		
13J. Reversal		

7.5 LIFE CYCLE TESTING REGIME (OPTIONAL)

TEST PROCEDURE	TEST UNIT ID No.	OTHER INFO
14A. Accelerated Aging		Use test matrix to specify one or more test regimes & accelerating factors
14B. Actual-Use Simulation		FUDS-based; specify ambient temperature regime
14D. Baseline Life Cycle		80% DOD DST discharge at nominal environmental conditions

8.0 **Special Measurement Requirements**

Identify or attach number/location of temperature measurements:

Identify or attach number/location of voltage and current measurements (other than overall):

Specify any special monitoring (not already identified) required to assure that abnormal battery conditions are detected:

9.0 **Post-Test Examination and Analysis**

Identify or attach requirements for post-test examination and/or any teardown and subsequent analysis after completion of testing:

APPENDIX B

**GENERIC REPORTING
AND
DATA ACQUISITION OUTLINE
FOR
PERFORMANCE AND LIFE TESTING
OF
ELECTRIC VEHICLE BATTERIES**

GENERIC REPORTING AND DATA ACQUISITION OUTLINE FOR ELECTRIC VEHICLE BATTERY TESTING

1.0 Purpose and Applicability

This outline defines the general formats and types of information to be acquired and reported to the U. S. Advanced Battery Consortium (USABC) for both the performance and life testing of electric-vehicle batteries. Sections 2 through 6 apply to reporting requirements. Data acquisition and retention requirements are described in Section 7.

1.1 Assumptions

This outline assumes the existence of a test plan that defines the testing to be performed on (each sample of) a given battery, the rationale (purpose) for this testing, and a body of procedures that specify in detail how to conduct each type of test. The test plan and the corresponding procedures should be referenced so that detailed procedural information need not be included in the reporting of test results.

The term ‘battery’ is used generically in this outline to designate any hardware test unit of whatever size, including cells, modules, battery packs and complete battery systems.

2.0 Test Report Format and Content

The general structure of a testing report is outlined below. Some reports may not contain all the indicated sections if less than the full spectrum of tests are performed. For example, not all batteries will be subjected to performance testing, life testing and post-test analysis. Also, the reported battery descriptive information may be limited if the battery in question is one of a group of identical items being tested. If interim reports are issued during testing, it may not be appropriate to repeat some information. In the most general case, however, testing reports should contain the following types of information:

- Executive Summary (Abstract, Conclusions, Recommendations)
- Testing Objectives
- Battery Descriptive Information
- Performance Test Results
- Life Cycle Test Results
- Post-Test Teardown and Analysis Results
- Conclusions
- Recommendations
- References

Each of these categories of information is briefly summarized below; subsequent sections treat those topics requiring more detailed definition.

2.1 Executive Summary

The executive summary is a compilation (limited to 1-2 pages) of the information that would be most significant to the casual reader. It should contain an abstract as the first part and a reiteration of any conclusions or recommendations contained in the report. The abstract itself is a brief statement (typically less than 200 words) of the purpose of the work, methods, and results. It should be a

stand-alone summary of what was done, the results, and any significance of the results.

2.2 Testing Objectives

A brief statement should be provided that describes the purpose(s) for which the reported testing was done. This should be agreed to with the USABC prior to the start of testing. A test plan for the battery should have been constructed to satisfy these objectives. The report should show how and to what extent these objectives are satisfied.

2.3 Battery Descriptive Information

A description of the battery or battery system that was tested is to be provided in sufficient detail to identify what was tested. This should include any general descriptive information that was not supplied by the developer or the USABC, e.g., battery weights, photographs of fabricated assemblies, etc. Additional information is provided in Section 3.

2.4 Performance Test Results. A description of test results to be reported from performance testing is provided in Section 4.

2.5 Life Cycle Test Results. A description of test results to be reported from life cycle testing is provided in Section 5.

2.6 Post-Test Teardown and Analysis Results. Results to be reported from teardown and analysis after performance or life-cycle testing are discussed in Section 6.

2.7 Conclusions

A conclusions section is to be included to summarize the significance of the reported results, with particular emphasis on (1) the degree to which testing objectives were satisfied; and (2) the extent to which the measured battery behavior approaches the USABC goals or other pre-established requirements for the technology.

2.8 Recommendations

Recommendations should be included where appropriate to convey technical judgments or opinions, suggestions for follow-on testing or problem resolution, or other information that goes beyond interpreting the test results. Recommendations should be directed specifically at battery developers, the USABC and its program managers.

2.9 References

The battery specific test plan and all procedures used in the conduct of reported testing should be referenced at the appropriate reporting stages so that these plans and procedures can be unambiguously related to the testing performed. This will permit subsequent questions about the possible influence of testing methods on test results to be addressed.

2.10 Other Information

Test reports should include adequate definition for nomenclature used in the reports, along with

acronyms and abbreviations where appropriate. Nomenclature should be consistent with the USABC glossary to avoid the need for extensive definitions.

3.0 Battery Information and Description

The initial information to be reported for any battery should be a description of the battery itself, in sufficient detail to unambiguously identify the battery and any unique conditions or limitations imposed on its testing. The intent of this information is two-fold: to clearly distinguish this particular battery and its test regime from other similar ones; and to document information other than test results that was acquired by the test laboratory during testing. In general this would include the following categories of information:

- Physical Characteristics (size, weight, number & condition of cells, interconnection, breakdown of auxiliary equipment etc.)
- Chemical/Electrochemical Characteristics (include manufacturer's specifications for capacity and power, cell voltage etc.)
- System Control, Thermal Management, Operating Description
- Battery Operating/Discharge Limits
- Charging Considerations and Requirements
- Safety Considerations (if they affect testing)

Where appropriate, this information should be supplemented by photographs or diagrams of the battery system and important components.

If only a single battery of a given type is tested, this information will normally be reported along with the performance test results. Where multiple samples of the same battery design are tested, this (common) information could be compiled once and supplied to the test sponsor after review by the laboratory(ies) conducting the testing. For multiple batteries, only the information common to all batteries need be included here; for example, if different charge algorithms are required for different test batteries, these different charging requirements can be included with the performance test results for each battery.

3.1 Battery Identification

A unique identifier will be assigned for each test battery by the USABC when the battery is delivered for testing. The battery information section will tabulate this identifier along with other descriptive data, so that all reported results can be easily related back to this identifier. The method for assigning the battery identifier is detailed in Appendix D.

4.0 Performance Test Reporting

Batteries may be subjected to a wide spectrum of performance tests, ranging from the minimum core tests (presently 6 cycles) to a test sequence requiring several months. Multiple samples of a given hardware deliverable may, in many cases, be subjected to a common test regime. Hence, the extent and frequency of performance test reporting must necessarily be tailored to the length of testing and number of test units. The minimum reporting from the testing of a single test unit is described in Section 4.1. For particular batteries, this summary information will be supplemented with appropriate graphical or other data of specific interest, as outlined in Sections 4.2-4.6. Note that this supplemental information is not expected to be provided for every battery tested; instead only selected samples of a given technology will be examined (as specified in test plans) for these aspects of battery behavior.

Where justified by the extent of testing, a final full report will be published at the conclusion of testing. This report may summarize the performance of an entire group of identical batteries; in some cases it may also include subsequent life cycle test results and/or post-test analysis results. Because of the delays inherent in generating such a report, summary performance test status information is required periodically (generally monthly) for any battery where testing lasts 2 months or more.

4.1 Summary Performance Test Results

Performance test results for each battery tested should be summarized using the format shown in Table B1. This table identifies the particular test unit and lists the key information derived from each type of test specified in the test plan as results become available. Where only minimum core testing is performed, this summary table may be the only performance test reporting required. In other cases, it will be updated as testing progresses and used for periodic reporting. Where a full performance test report is prepared, the final version of this table will be appended to the report.

Where multiple identical samples of a battery are subjected to common test conditions, an overall summary of the test results for each battery in such a group should be provided to permit easy comparison of their performance. A suggested format for such an extended results summary is shown in Table B1a. This may be extended where appropriate to include multiple groups for a given technology. The suggested format for such a high-level summary is shown in Table B2.

In addition to summarizing the general performance test results, these tables provide a mechanism for showing cycle life and for noting any changes in test conditions or battery configuration that occurred during testing.

4.2 Battery Capacity

The measured capacity of the battery in ampere-hours and watt-hour or kilowatt-hours should be reported for the following test regimes if performed:

- Constant Current Discharge
- Constant Power Discharge
- Variable Power Discharge (DST/FUDS)

These results should be representative, in that they are likely derived from multiple tests. For batteries that require time or exercise to reach a stable capacity, both the initial and the stable capacities should be reported.

4.3 Voltage-Current Behavior

Battery voltage (over time or as a V-I plot) should be reported graphically for variable power discharge cycles. This should include open circuit voltage behavior during the rest periods (if any) and after the end of discharge. Voltage-current behavior during a charge cycle should also be reported graphically. For batteries incorporating multiple modules or sub-units, a graphical representation of the voltage variations between modules should be reported for one or more constant current or constant power tests.

Table B1. Summary Test Results

HARDWARE CHARACTERIZATION SUMMARY			
USABC ID: _____		REPORTING DATE: _____	
START DATE: _____		COMPLETION DATE: _____	
(* CORE TESTS)		Weight (kg): _____	
		Volume (L): _____	
		Basis: _____	
PROCEDURE#	DESCRIPTION	RESULTS	COMMENTS
2 (part)	C/3 Capacity Verification	____ Ah ____ Wh	
2	Charge/Dischg Effic: (Coul)	____ % Ah	(Describe Charge Method)
	(Energy)	____ % Wh	
12	Fast Charge	__ % Ah __ % Wh	
2	* Constant Current @ C/3	____ Ah ____ Wh	
	Constant Current @ C/2	____ Ah ____ Wh	
	Constant Current @ C/1	____ Ah ____ Wh	
4	* Constant Power @ ____ W	____ Ah ____ Wh	(Highest value [CORE TEST] should be that required to remove 75% of battery energy in 1 hour)
	Constant Power @ ____ W	____ Ah ____ Wh	
	Constant Power @ ____ W	____ Ah ____ Wh	
5	* Variable Power w/DST or FUDS	____/____ Wh net/gross ____/____ Ah net/gross	(For DST, report Wh & Ah at unreduced and reduced power conditions, and any procedure deviations)
3	* Derived Peak Power (30s at 80% DOD)	____ W	(Note the rated peak power if significantly different than the derived value.)
7	Stand time ____h	% Loss	
8	Hill Climb (6 minutes)	Max. % DOD	
6	Partial Discharge	% Loss	
14	Life (DST) Status (cyclng start date ____)	__ Cycles total __ Cycles DST	(Also report most recent Reference Performance Tests: capacity on DST, 80% DOD power on Peak Power)

Note: for multiple identical deliverables, this table may be extended with additional Results columns. See Table B1a for example.

Table B1a
Summary Test Results (Extended for Multiple Test Units)

Report Date: _____

USABC Number(s) _____

Procedure	Description	Units	M1	M2	M3	M4	M5	M6	M7	M8	M9	M10
1	Mass Volume	kg l										
2 (part)	C/3 Capacity	Ah Wh/kg Wh/l										
2 (part)	Efficiency	% Ah % Wh										
12	Fast Charge	% Acceptance										
2	CC @ C ₃ /3 CC @ C ₂ /2 CC @ C ₁ /1	Ah Ah Ah										
4	CP @ E ₃ /3 CP @ E ₂ /2 CP @ E ₁ /1	Wh/kg Wh/kg Wh/kg										
5	Variable Power DST	Wh/kg Wh/l										
3	Peak Power 30s @ 80% DOD	W/kg W/l										
7	Stand Test 1h 48h 168	% Loss % Loss % Loss										
8	Hill Climb (6m)	Max. % DOD										
6	Partial DOD Cycles to Full	% Loss Cycles										
14	Life: Peak Pwr 3h Rate DST	Cycles Cycles Cycles										
	Test Plan (Brief Description)											

Note: Comments on Table B1 should be observed for this summary test results table also.

Table B2
Summary Test Results (Multiple Groups of Identical Test Articles)

Report Date: _____

PERFORMANCE AND STATUS SUMMARY OF _____ CELLS/MODULES/BATTERIES UNDER TEST AT _____											
Identification Number	Weight kg	Volume L	Specific Energy C/3		Net Specific Energy DST				Peak Power @ 80% DOD, W/kg		Total & DST Cycles Accrued As of ___
			Initial Ah Wh/kg	Present Ah Wh/kg	Initial Ah Wh/kg	Present Ah Wh/kg	Initial	Present			

NOTE: Weights or volumes used for calculating normalized performance values (e.g. Wh/kg, Wh/l, W/kg) should be the actual measured values of the units under test; otherwise a clearly defined basis for these values must be provided.

4.4 Other Observations

Observed battery behavior that could significantly affect the interpretation or understanding of test results should be noted in narrative fashion. This may include, for example, deviations from procedures due to equipment or battery limitations, or test anomalies which are outside the expected range of results. Also reliability or maintenance concerns that might affect the suitability of the battery for life cycle testing should be reported.

5.0 Life Cycle Test Reporting

Summary status tables (e.g., Tables B1 and B2) are to be used as the basic means of reporting accumulated cycles and degree of performance degradation during life cycle testing. This status report (with accompanying pertinent graphical data) will be provided throughout the lifetime of the unit under test at periodic intervals. This reporting will act as a supplement to the summary reports provided during performance characterization. The final report will summarize the life cycle history of the test unit (or an entire group of identical batteries where appropriate.)

5.1 Life Cycle Tests

For any selected life-cycle testing regime, the initial test(s) should be reported in the same level of detail as the comparable (variable power discharge) performance test. Reporting for subsequent tests should be confined to a small number of selected parameter values, preferably as specified in the test plan. For example, if a life cycle discharge is to be terminated after a fixed number of Ah is removed from the battery, the voltage at end of discharge should be reported; conversely, if the test is terminated on a predetermined voltage limit, the battery capacity should be reported. A graphical representation of the selected parameters versus (cumulative) cycle count should be provided.

5.2 Frequency of Reporting

Because life-cycle tests on a given battery may require months or years to complete, the reporting of such results should take place on a periodic basis to provide timely status information to the test sponsor. Initial life cycle test results will be reported in accordance with the test plan (e.g., after the second RPT set is performed). Subsequent status updates would then be provided at agreed-on intervals (e.g. monthly or quarterly) depending on the expected duration of the testing.

Note: additional guidance for periodic reporting of test results (e.g. quarterly and/or weekly) is under development and will be provided in a future revision to this manual.

6.0 Post-Test Teardown and Analysis Reporting

Detailed procedures for post-test teardown and analysis have not yet been defined. Presumably, the results of such analyses would be reported as photographic/microphotographic records, chemical analysis values, and narrative information. Requirements for such analysis (and resulting reporting) should be specified in the test plan for each test unit.

7.0 Data Acquisition and Retention Requirements

7.1 Measurement Parameters

The basic requirement of the data acquisition system is to sample battery parameters in a manner that assures that the test unit response to load demand can be accurately measured and/or reproduced.

All battery discharge/charge cycling requires three fundamental measurements: voltage, current, and temperature. Measurement to be performed during vibration testing are described separately in Procedure #10. The time that each parameter is sampled is recorded with the measurement. For laboratory charge/ discharge testing, it is generally adequate to derive battery power from the multiplication of current and voltage. However, if more than 1 millisecond elapses between any voltage and current samples used to derive power, a power measurement instrument must be used to acquire battery power information.

Data acquired from these measurements is used to derive the remaining battery discharge/charge parameters such as cell/module/battery resistance, capacity (ampere-hours), and energy (watt-hours).

7.2 Test Modes and Data Sampling Requirements

The modes in which electrical testing may be performed on a battery are as follows:

- Constant Current Discharge (CC)
- Constant Power Discharge (CP)
- Variable Power Discharge (VP) FUDS, DST
- Peak Power Discharge (PP) (is a Variable Current Discharge)
- Recharge (RCG) (CC and/or CP)

These tests modes have varying sample requirements. Recharge, Constant Current Discharge, and Constant Power Discharge testing require a minimum of one sample (a) every 10 minutes or (b) whenever any measurement changes by more than 2% of its previous value (of current, voltage or temperature) to be recorded during the full duration of a test.

Variable Power or Peak Power discharge tests require sampling of all measurements at a minimum of one sample per second during periods of current or power changes. Acquisition systems capable of programmable sampling may be set up to reduce the amount of data storage by decreasing sampling during static portions of tests (e.g. the constant current periods during a Peak Power Test.) If sample rates for slowly moving parameters such as temperature can be programmed independently, further reduction in the amount of stored data may be effected by decreasing the number of samples (per channel) for such parameters to the same as those required for RCG, CC or CP tests.

Sampling requirements for Life Cycle DST discharges (Procedure #5A) may be reduced by the following two-step process: (a) sampling test unit voltage and current (only) near the beginning and end of each power step in a DST profile; and (b) sampling all measurements near the end of the maximum discharge (100%) and maximum regen (50%) steps for each 360 second DST profile completed.

7.3 Measurement Accuracies

Required accuracies for the respective measurements are:

<u>Measurement</u>	<u>Accuracy</u> <u>(% of Reading except as noted)</u>
Voltage	< 1.0
Current	< 1.0
External Temp	+/- 3°C
Internal Temp	+/- 3°C
Ambient Temp	+/- 3°C
Power	< 3.0
Vibration (Accel)	< 4.0

The implied accuracy for other derived (calculated) data such as accumulated energy or Ah capacity is data system dependent but generally should not exceed 3%.

7.4 Data Retention

For each discharge/charge cycle during both performance and life cycle testing, a tabulation of summary data, including cycle number, test duration, calculated values (e.g., energy and capacity), and starting and ending values for parameters such as open circuit voltage and temperature, will be permanently retained.

For the characterization performance tests and the Reference Performance Tests during life cycle testing, the minimum number of samples identified in Section 7.2 should be retained permanently for each discharge/charge cycle.

For life cycle testing, the recorded data identified in Section 7.2 must be retained a minimum of 2 months, after which it can be deleted (except for summary results) with the written consent of the program manager. Any summary results that must be retained for each life cycle should be identified in the test plan.

7.5 Data Formats

Test results and other data may be retained in at least 4 formats as appropriate: narrative, numerical/tabular, graphical, and computer files. All data to be retained should be stored in permanent, secure, and backed-up computer files. For graphs having relatively few data points, the values should also be retained and reported in numerical/tabular form for subsequent analysis use.

APPENDIX C

DOE BATTERY LAB DST-CAPABLE CYCLING EQUIPMENT

DOE BATTERY LAB DST-CAPABLE CYCLING EQUIPMENT

LAB	EQPT TYPE	MFGR.	RATINGS ¹	NO. UNITS
ANL	BATTERY CYCLER	ROBICON	250V -1200A +300A	4
ANL	BATTERY CYCLER	DYNAPOWER	100V \pm 500A	1
ANL	BATTERY CYCLER	DYNAPOWER	500V \pm 500A	3
ANL	MODULE CYCLER	TRANSREX	20V \pm 500A	30
ANL	MODULE CYCLER	PROPEL	20V \pm 500A	11
ANL	MODULE CYCLER	EMI	20V \pm 1000A	3
ANL	CELL CYCLER	ARGONNE	10V \pm 20A	2
ANL	MICRO-CYCLER	ARGONNE	10V -1,+3.A	5
SNL	BATTERY CYCLER	SNL	21V +240A -600A \leq 5KW	4
SNL	MODULE CYCLER	SNL	48V +250A -300A \leq 4KW	10
SNL	CELL CYCLER	SNL	40V +30A -100A \leq 1kW	12
SNL	CELL CYCLER	SNL	10V \pm 10A \leq 100W	12
SNL	BATTERY CYCLER	DYNAPOWER	500V \pm 500A	1 ²
SNL	CELL CYCLER	MACCOR	-5V to +20V \pm 20A	8
SNL	CELL CYCLER	MACCOR (* no. channels includes some in following tester)	-10V to +6v \pm 1A 6V \pm 1A 6V \pm 0.25A \pm 6V \pm 0.025A	8 24* 24* 16*
SNL	CELL CYCLER	MACCOR	-10V to +25V \pm 2A 25V \pm 2A 6V \pm 2A -5V to +6V \pm 1A	6 6 6 6
INEL	BATTERY CYCLER	ENERGY SYS	500V -500A +250A \leq 100KW CONT.	3
INEL	MODULE CYCLER	BITRODE	20V -500A +150A \leq 10KW CONT.	2
INEL	BATTERY CYCLER	FCI	220V -400A 300V +150A	1
INEL	MODULE/CELL CYCLER	MACCOR	20V \pm 12.5A	21
INEL	MODULE CYCLER	MACCOR	100V \pm 5A	2
INEL	MODULE CYCLER	MACCOR	100V -50A +25A	1
INEL	CELL CYCLER	MACCOR	5V -50A +25A	8
INEL	CELL CYCLER	MACCOR	5V -5A +2.5A	16
INEL	MODULE CYCLER	ENERGY SYS	100V -20A +10A ³	24 ²
INEL	BATTERY CYCLER	DYNAPOWER	500V \pm 500A	1 ²

NOTES:

1. (+) IN RATINGS COLUMN DENOTES CHARGE CURRENT RATING
2. ON ORDER
3. PARALLELABLE IN GROUPS UP TO 8 CHANNELS

APPENDIX D

METHODOLOGY FOR ASSIGNING USABC IDENTIFICATION NUMBERS

APPENDIX D

Methodology for Assigning USABC Identification Numbers

Purpose

All battery cells, modules and packs to be evaluated with USABC support will be assigned an identification number by the responsible USABC Program Manager. This number will be furnished to the USABC Testing Coordinator and to the laboratory designated for testing the particular unit.

Process

The USABC identification number will contain the following descriptor fields in the specified order. Field #6 will be used only when a change is made to the makeup of a test unit.

1. Type of technology: Use 2 letters to identify.

Examples: SS- sodium sulfur; LP - lithium polymer; NH - nickel metal hydride; ZA - zinc air; LD - lithium iron disulfide.

2. Size of unit: Volts/capacity in ampere-hours.

Example: 8/300 (i.e., 8 volts, 300 A·h)

3. Date of fabrication/delivery: A 4 digit code including month and year (MMYY)

Example: 0294

4. Manufacturer's identification: A 3 letter code including (generally) the first letter from each word in the manufacturer's name.

Examples: SPL - Silent Power Limited, GRA - W. R. Grace, OBC - Ovonics Battery Corporation

5. Serial number of unit: a consecutive number as delivered from a particular manufacturer, with a prefix of C (for cell), M (for module) or P (for pack). All manufacturers will assign their own number to each test unit before delivery. The USABC identification number should be cross-referenced to the manufacturer's number. Preceding zeros need not be included.

Examples: C1, M2, P3 (not M01)

6. If a cell or group of cells are removed from a module or pack and replaced with different cells, the manufacturer will assign all sub-units a serial number. The USABC Program Manager will note this information and then add a lower case 'a', 'b', 'c'... at the end of the standard identification number to designate a change in the unit. This information, along with other information pertaining to the number of cells changed, reason for replacement, cell replacement location etc. will be provided to the USABC Testing Coordinator and the laboratory that is testing the unit. This change identification may also be used to identify changes other than cell replacement.

Complete Example of Identification Convention

On March 1, 1993, ten 2V, 10 A-h single cells and ten 120-cell 8V, 300 A-h sodium-sulfur modules from Silent Power Limited are delivered to the USABC for testing. The following test unit identifiers should be assigned:

Cells

SS2/10-0393-SPL-C1 ... SS2/10-0393-SPL-C10

Modules

SS8/300-0393-SPL-M1 ... SS8/300-0393-SPL-M10

After the modules have been on test for six months, string #1 in module #5 fails, and the USABC decides to replace this string and continue testing the module. The new descriptor for this module becomes the following:

SS8/300-0393-SPL-M5a

Information about the string number that was removed and other pertinent data will be provided to and recorded by the USABC Testing Coordinator and the testing laboratory.

APPENDIX E

WORKSHEET FOR MANUFACTURER-SUPPLIED TESTING INFORMATION

Worksheet for Manufacturer-Supplied Testing Information

Note: All items should be completed; use N/A (not applicable) where appropriate

GENERAL

Manufacturer: _____

Technology: _____

ID Number: _____

Test Unit Configuration: (e.g. __Series x __Parallel cells etc.)__

RATINGS

RATED CAPACITY: _____ A h (This value is used for all performance tests, and 'percent DOD' is always relative to this value.)

CAPACITY (for Constant Current Testing - Procedure 3)

- At C/3 Discharge Rate: _____ A·h
- At C/2 Discharge Rate: _____ A·h
- At C/1 Discharge Rate: _____ A·h

ENERGY (for Constant Power Testing - Procedure 4)

- At C/3 Discharge Rate: _____ W·h

PEAK POWER (for Peak Power Testing - Procedure 6)

- At 80% DOD & 2/3 OCV: _____ W (A higher [more restrictive] voltage value can be used for rating if specified under Limits.)

OTHER: _____ (specify conditions)

MEASUREMENTS

WEIGHT: _____ kg (actual test unit)

VOLUME: _____ L displacement (actual test unit)

DIMENSIONS: _____ Length (cm maximum)
_____ Width (cm maximum)
_____ Height (cm maximum)

OPEN CIRCUIT VOLTAGE at 80% DOD: _____ V (for Peak Power testing)

OTHER: _____

LIMITS (not permitted to be exceeded during testing)

VOLTAGE

Discharge (minimum)

C/3: _____ V E/1.33: _____ V
C/2: _____ V E/2: _____ V
C/1: _____ V E/4: _____ V

8 second peak power pulse: _____ V
30 second peak power test: _____ V (**cannot be less than 2/3 OCV at 80% DOD at beginning of life**)

Other: _____ V (specify conditions, e.g. OCV)

Charge (maximum)

Sustained: _____ V
Pulse regen (< 8 seconds): _____ V
Other: _____ V (specify conditions)

CURRENT (maximum)

Discharge

Sustained (1 hour): _____ A
< 30 seconds: _____ A
< 8 seconds: _____ A
Other: _____ A (specify conditions)

Charge

Sustained: _____ A
Pulse regen (< 8 seconds): _____ A
Other: _____ A (specify conditions)

TEMPERATURE

Nominal Operating: _____ °C to _____ °C
To Start Discharge: _____ °C (specify min or max)
To Start Charge: _____ °C (specify min or max)
During Discharge: _____ °C (specify min or max)
During Charge: _____ °C (specify min or max)
Other: _____ °C (specify conditions)

CHARGE PROCEDURE

Normal: _____

Fast Charge: _____

APPENDIX F

GLOSSARY OF BATTERY AND BATTERY TESTING TERMINOLOGY FOR THE USABC BATTERY TEST PROCEDURES

Glossary of Battery and Battery Testing Terminology for the USABC Battery Test Procedures

acceleration power (kW)	The battery power required to accelerate an electric vehicle from zero to a specified speed in a specified time. The battery voltage must be maintained above a specified minimum. For example, 50 kW acceleration power may be required when a vehicle is accelerated from 0 to 80 km per hour in 20 seconds, with battery voltage maintained above 2/3 of the open-circuit voltage (highest open-circuit encountered through entire state of charge) during the 50-kW discharge.
active materials	The constituents of a cell that participate in the electrochemical charge/discharge reactions. Specifically, this normally does not include separators, current collectors, catalysts or supports.
active material area loading (g/cm ²)	The weight of active material per unit electrode area.
active material loading density (g/cm ³)	The weight of active material per unit electrode volume.
anode*	The electrode in an electrochemical cell at which oxidation takes place. During discharge, the negative terminal of the cell is the anode; however, during charge, the positive terminal of the cell is the anode. For rechargeable batteries, the electrodes are normally referred to according to the reactions that occur during discharge.
average power (kW)	Total energy withdrawn (or returned) from (or to) a battery divided by the time of discharge (or charge).
average voltage (V)	The ratio of the watt-hours delivered to the Ampere-hours delivered for a given discharge or charge. Not necessarily a simple average of voltage over time. Also known as <i>current weighted voltage</i> .
battery	Electrochemical cells electrically connected in a series and/or parallel arrangement.
battery cell	An assembly of at least one positive electrode, one negative electrode, and other necessary electrochemical and structural components. A cell is a self-contained energy conversion device whose function is to deliver electrical energy to an external circuit via a controlled internal chemical process. This chemical-to-electrical energy conversion process involves ionic transport between electrodes having different potentials.
battery module	The smallest grouping of physically and electrically connected cells that can be replaced as a unit. A module can be thought of as the smallest, repeating building block of a battery pack.
battery pack	An array of interconnected modules that has been configured for its intended energy storage application, that is, the configuration is application dependent.
battery system	Completely functional energy storage system consisting of the pack(s) and necessary ancillary subsystems for physical support, thermal management, and electronic control.

Terms marked with an asterisk (*) are ambiguous; their use is discouraged.
Letters enclosed in brackets { } are commonly used abbreviations.

battery system mass fraction	Ratio of battery system weight to gross vehicle weight.
battery volume (l)	The volume of the battery. Cell, module, pack, or system should be specified, and should include the usable volume displaced.
battery weight (kg)	The weight of the battery. Cell, module, pack, or system should be specified.
calendar life	The length of time a battery can undergo some defined operation before failing to meet its specified end-of-life criteria.
capacity {C} (Ah)	The total number of Ampere-hours that can be withdrawn from a fully charged battery under specified conditions. Also referred to as <i>coulombic capacity</i> .
available, or deliverable, capacity (Ah)	The total ampere-hours that can be withdrawn from a fully charged cell or battery for a specific set of operating conditions including discharge rate, temperature, age, stand time, and any discharge cutoff criteria specified by the battery manufacturer.
C_i (Ah)	The capacity in Ampere-hours obtained from a battery discharged at a constant current to an end-of-discharge condition (discharge cutoff voltage) in precisely i hours. C_i is established once and is not adjusted through the battery's life.
energy output, or energy capacity* (Wh)	The total watt-hours that can be withdrawn from a fully charged battery for a specific set of operating conditions including temperature, rate, age, stand time, and discharge cutoff criteria (specified by battery manufacturer).
rated capacity (Ah)	The developer's or manufacturer's specification for capacity. This single value is chosen by the manufacturer to best represent the expected performance of the item when tested under all the conditions of this manual.
residual capacity (Ah)	The Ampere-hours that can be discharged from a battery at a specified discharge rate and temperature after it has been exposed to specified conditions, such as driving-profile or open-circuit stand tests.
specific capacity (mAh/g)	Capacity per unit weight of active material. This term is usually applied to active materials and/or electrodes (that is, including current collectors).
theoretical capacity (Ah)	The capacity of a cell's active material, assuming 100% utilization.
capacity area density (mAh/cm ²)	The electrochemical capacity of active material per unit electrode area.
cathode*	The electrode in an electrochemical cell at which reduction takes place. During discharge, the positive terminal of the cell is the cathode; however, during charge, the negative terminal of the cell is the cathode. For rechargeable batteries, the electrodes are normally referred to according to the reactions that occur during discharge.
cell	See battery cell.

Terms marked with an asterisk (*) are ambiguous; their use is discouraged.
Letters enclosed in brackets { } are commonly used abbreviations.

cell, secondary	A cell, as described herein (see battery cell), with two additional attributes: rechargeability and energy storage. Rechargeability is the application of electricity in order to repeatedly reverse the internal chemical process once the chemical energy has been discharged. Energy storage is the retention of recharged chemical energy with minimal losses during periods when the cell is not in use.
charge	Conversion of electrical energy into chemical potential energy within a cell by the imposed passage of a direct current.
charge profile	Schedule used for charging a battery. For example:
constant current charging {CI}	Charging of a battery at a controlled, constant rate of electron flow (normally applied with a maximum voltage limit).
constant voltage (potential) charging {CV}	Charging of a battery by applying a constant voltage while allowing the current to vary (normally applied with a maximum current limit).
CI/CV	A constant current charge followed by a constant-voltage charge. See also finishing charge rate, float charge, and trickle charge.
charge rate {C _i /X} (A)	The current applied to a battery to restore its available capacity. The current can be expressed in amperes, but more commonly it is normalized to the rated capacity (C) of the battery, and expressed as C _i /X, where i is the hour rate for the rated capacity, and X is a time specification, usually in hours. If i is not given, it is assumed to be the same as X. For example, the 10-hour charge rate of a 500-ampere-hour battery (rated at the 5-hour discharge rate) is expressed as <div style="text-align: center;"> $\frac{\text{rated capacity}}{\text{charge time}} = \frac{500 \text{ ampere-hours}}{10 \text{ hours}}$ $= 50 \text{ amperes} = C_5/10 \text{ rate.}$ </div> <p>In contrast, the capacity of the same battery rated at the 3-hour discharge rate might be 450 Ampere-hours, giving a 10-hour charge rate of</p> $450/10 = 45A = C_3/10 \text{ rate.}$
core performance tests	The minimal set of tests that must be initially performed on every USABC test unit, and which is a subset of the general performance characterization tests. Refer to Figure 1. Outline of USABC Laboratory Battery Testing Process in this manual for a list of included tests.
current {I} (A)	The rate of flow of electricity in a circuit.
current collector	A part of an electrode that conducts electrons. It may also serve as a structural support for the electrode.
current density (mA/cm ²)	The current per unit electrode area. Determined by dividing the charge or discharge current by the total geometric (projected) area of the positive or negative electrode.
cutoff voltage (V)	The battery voltage at which charge or discharge is terminated.

Terms marked with an asterisk (*) are ambiguous; their use is discouraged.
Letters enclosed in brackets { } are commonly used abbreviations.

cycle	The period commencing from the start of one charge/discharge to the start of the next charge/discharge where said period includes discharge time, open-circuit time, and charge time. The depth of discharge (or percentage of capacity) associated with each cycle must be specified.
cycle life	The number of cycles, each to specified discharge and charge termination criteria, such as depth-of-discharge, under a specified charge and discharge regime, that a battery can undergo before failing to meet its specified end-of-life criteria.
deep discharge	A qualitative term indicating the withdrawal of a significant percentage of capacity (typically, 80 percent or more).
depth-of-discharge {DOD} (%)	The ratio of the net Ampere-hours discharged from a battery at a given rate to the rated capacity.
discharge	Spontaneous conversion of chemical potential energy into electrical energy within a cell, which results from allowing the passage of direct current.
discharge regime	Schedule used for battery discharge that follows a particular current (or power) versus time sequence. Recharge segments may be included. The USABC's Dynamic Stress Test (DST) is a discharge regime commonly used to evaluate the service life of EV batteries.
discharge profile	The longest, unique repeating unit of a discharge regime (specifically, 360 sec for the DST; 1372 seconds for the FUDS)
discharge segment	A subsection of a profile. A convenient, contiguous grouping of specific steps in a profile.
discharge step	A change from one power level to another in a discharge profile.
discharge rate {C _i /X} (A)	The current during discharge of a battery. The current can be expressed in amperes, but more commonly it is normalized to the rated capacity (C) of the battery, and expressed as C _i /X, where <i>i</i> is the hour rate for the rated capacity, and X is a time specification, usually in hours. If <i>i</i> is not given, it is assumed to be the same as X. For example, the 10-hour discharge rate of a 500-ampere-hour battery (rated at the 5-hour discharge rate) is expressed as <p style="text-align: center;"> $\frac{\text{rated capacity}}{\text{discharge time}} = \frac{500 \text{ ampere-hours}}{10 \text{ hours}}$ $= 50 \text{ amperes} = C_5/10 \text{ rate.}$ </p> <p>In contrast, the capacity of the same battery rated at the 3-hour discharge rate might be 450 Ampere-hours, giving a 10-hour discharge rate of</p> $450/10 = 45A = C_3/10 \text{ rate.}$
Discharge Voltage Limit	The minimum voltage under load permitted during performance of the Peak Power Test and other performance tests. It is equal to 2/3 of the open circuit voltage at 80% DOD at beginning of life, unless the manufacturer specifies a more restrictive (higher) value.
DOD	See depth-of-discharge.

Terms marked with an asterisk (*) are ambiguous; their use is discouraged.
Letters enclosed in brackets { } are commonly used abbreviations.

driving profile	A schedule of vehicle speed versus time that is used to test vehicle and battery characteristics.
Dynamic Stress Test (DST)	A variable-power discharge regime, developed by USABC to simulate expected demands of an EV battery. This specific regime can effectively simulate dynamic discharging and can be implemented with equipment at most test laboratories and developers.
DST _n	A label for reporting DST test results which indicates that the data result from a DST scaled to a peak power value of n W/kg.
efficiency (%)	The ratio of the useful output to the input:
coulombic (Ah-) (%)	The ratio of the Ampere-hours removed from a battery during a discharge to the Ampere-hours required to restore the battery to the state of charge before the discharge was started: <div style="text-align: center; margin: 10px 0;"> $\frac{\text{ampere-hours discharged}}{\text{ampere-hours charged}} = \frac{\int_0^{t_d} i_d dt}{\int_0^{t_c} i_c dt}$ </div> <p>where i_d and i_c are the discharge and charge currents, respectively, and t_d and t_c are the discharge and charge times, respectively.</p>
energy (watt-hour, round trip) efficiency (%)	The ratio of the net DC energy delivered by a battery during a discharge to the total DC energy required to restore the initial state-of-charge: <div style="text-align: center; margin: 10px 0;"> $\frac{\text{watt-hours discharged}}{\text{watt-hours charged}} = \frac{\int_0^{t_d} i_d v_d dt}{\int_0^{t_c} i_c v_c dt}$ </div> <p>where v_d and v_c are the discharge and charge voltages, respectively, i_d and i_c are the discharge and charge currents, respectively, and t_d and t_c are the discharge and charge times, respectively. The watt-hour efficiency is equal to the product of the voltaic and coulombic efficiencies.</p>
voltaic (%)	The ratio of average voltage during discharge of a battery to the average voltage during charge with the prior or subsequent restoration of an equivalent capacity.
battery system energy efficiency (%)	Round trip <i>battery system</i> energy efficiency should be distinguished from general energy efficiency as defined above. It must include energy losses resulting from self-discharge, cell equalization, thermal loss compensation, and all battery-specific auxiliary equipment.
electrode	The conducting body that contains active materials and through which current enters or leaves a cell.
electrolyte	The medium that provides ion transport between the positive and negative electrodes of a cell. It may participate directly in the charge/discharge reactions.

Terms marked with an asterisk (*) are ambiguous; their use is discouraged.
Letters enclosed in brackets { } are commonly used abbreviations.

end-of-charge voltage {EOCV} (V)	The battery voltage when charge is terminated.
end-of-discharge voltage {EODV} (V)	The battery voltage when discharge is terminated.
end-of-life	The stage at which the battery meets specific failure criteria (e.g., capacity and/or power degradation). Specifically, when either: <ul style="list-style-type: none"> (1) the net delivered capacity of a cell, module, or battery is less than 80% of its rated capacity when measured on the DST (Reference Performance Test); or (2) the peak power capability (determined using the Peak Power Test) is less than 80% of the rated power at 80% DOD.
end of (life cycle) test	The condition that occurs when the actual performance of the test unit degrades to a level defined in the test plan and life-cycle testing is to be terminated. This end-of-test condition may or may not be related to end-of-life depending on test plan objectives.
energy density (Wh/l)	The rated energy of a battery (Wh) divided by the total battery volume (l). Also referred to as volumetric energy density.
equalization	The process of restoring all cells in a battery to an equal state-of-charge. This can consist of a prolonged charge or a complete discharge to a shorted condition, depending on the battery technology.
failure criteria	Specific battery performance characteristics that, when reached, indicate the battery can no longer perform its intended duty cycle.
finishing charge rate (A)	The current specified for completing the charging of a battery that is nearing 100% state of charge.
float charge	Charging a battery at a fixed voltage for extended periods of time to obtain or maintain the fully charged condition.
FUDS	Federal Urban Driving Schedule. The Environmental Protection Agency (EPA) urban dynamometer driving schedule, as defined in 40 CFR (Code of Federal Regulations), paragraph 86.115-78. A velocity-versus-time profile defined by the EPA to test for vehicle emissions and city fuel economy. When used as a laboratory battery test, a vehicle must be specified to derive a scaleable, power-versus-time profile from the velocity profile.
gassing	The evolution of gas at the interface between the electrolyte and the surface of an electrode (or both electrodes) in a cell.
grid	The framework for a plate or electrode that supports or retains the active materials and acts as a current collector. It is also known as the substrate.
high-rate discharge	A qualitative term indicating a discharge rate that is usually greater than the $C_i/1$ rate, e.g., $2C_i$ rate, where i is an integer denoting the rate at which C was determined. See discharge rate (C_i/X)

Terms marked with an asterisk (*) are ambiguous; their use is discouraged.
Letters enclosed in brackets { } are commonly used abbreviations.

hour rate (h)	The charge or discharge current of a battery expressed in terms of the length of time a new, fully charged battery can be discharged at a specific current before reaching a specified end-of-discharge voltage. For example, the 10-hour rate for discharging a 500-ampere-hour cell (rated at the 5-hour rate) would be 50 amperes. See charge rate or discharge rate.
internal impedance (ohm)	Opposition to the flow of an alternating current at a particular frequency in a battery at a specified state-of-charge and temperature.
internal resistance (ohm)	Opposition to direct current flow in a battery. Its value may vary with the current, state-of-charge, age, and temperature. It is the sum of the ionic and electronic resistances of the cell components.
long-term	Design feasibility and performance benefits demonstrated by vehicle tests of full-scale experimental batteries by mid-year 1995.
memory effect	A temporary loss of available battery capacity because of repetitive cycling to less than 100% DOD.
mid-term	Performance demonstrated by vehicle road-test of full-scale experimental batteries. Volume production and processing capability demonstrated by limited-run prototype production in a pilot plant by mid-year 1995.
minimum discharge voltage*	See Discharge Voltage Limit
negative electrode	Of the two electrodes comprising a cell, the electrode at which the associated half-cell reaction has the lower potential. It is negative in voltage relative to the other electrode of the cell. It is the electrode at which oxidation occurs during (spontaneous) discharge of the cell.
net Ampere-hours (Ah)	For a discharge test including both negative (discharge) and positive (regen) current or power steps, the difference between the Ah removed from the battery during discharge steps and the Ah returned to the battery during regen steps, regardless of battery charge acceptance.
nominal operating voltage (V)	The voltage of a battery, as specified by the manufacturer, discharging at a specified rate and temperature.
nonaqueous batteries	Batteries that do not contain water, such as those with molten salt, organic liquid, organic solid, or inorganic solid electrolytes.
open-circuit, IR-free, voltage { V_{IRFree} OCV} (V)	The voltage of a battery (at a specified state-of-charge and temperature) in the absence of charge or discharge current. It varies during the period following a charge or discharge and with state-of-charge. Also known as <i>no-load voltage</i> , it is a dynamic, derived value. At steady-state (with no current), the IR-free OCV approaches the true open-circuit voltage
overcharge (Ah)	The amount by which the charge Ampere-hours exceed the Ampere-hours removed on the previous discharge, sometimes reported as a percentage. Occasionally, this excess is normalized to the rated capacity.

Terms marked with an asterisk (*) are ambiguous; their use is discouraged.
Letters enclosed in brackets { } are commonly used abbreviations.

performance degradation	The extent to which the battery system is unable to meet the original performance specification or rating established for the battery. Performance characteristics of interest include capacity and power requirements, as well as other standards, such as, energy efficiency and charge retention. See end-of-life.
Peukert curve	Plot of the logarithm of the discharge rate versus the logarithm of discharge time to a specified end-of-discharge voltage.
polarization (V)	The voltage deviation from equilibrium open-circuit voltage caused by the flow of current in a battery.
positive electrode	Of the two electrodes comprising a cell, the electrode at which the associated half-cell reaction has the higher potential. It is positive in voltage relative to the other electrode of the cell. It is the electrode at which reduction occurs during (spontaneous) discharge of the cell.
power	
continuous (W)	A power level characteristic of a battery providing constant power for constant speed vehicle operation. Nominally, the power level required to remove 75% of the rated energy from the battery in 1 hour. Refer to <u>Procedure #4</u> , for details.
peak (W)	The 30s sustained pulse power obtainable from a battery under specified conditions. The peak power (at a given DOD) can be calculated by deriving the battery resistance and equivalent IR-free voltage from measured changes in battery voltage and current (at the given DOD). Refer to <u>Procedure #3</u> for details.
rated (W)	The manufacturer's specification of the discharge power capability of a battery.
regen (W)	The power delivered to a battery during regenerative braking.
power density (W/l)	The rated power of the battery (W) divided by the total volume of the battery (l). Also referred to as volumetric power density. Other common (and similarly derived) terms include peak power density and continuous power density.
power-to-energy ratio {P/E} (h ⁻¹)	Ratio of the peak power obtained under specified conditions, such as depth-of-discharge, to the energy output obtained under specified discharge conditions.
Ragone curve	Plot of the specific energy as a function of the continuous specific power at which the battery is discharged. Originally defined as the set of curves ranging between the high-power design and the high-energy design for a particular technology.
recharge factor	The inverse of the coulombic efficiency, expressed as a ratio, for a cycle.
reference performance test (RPT)	The set of tests to be performed periodically to monitor performance degradation during life-cycle testing. Refer to <u>Procedure #14C</u> for details.

Terms marked with an asterisk (*) are ambiguous; their use is discouraged.
Letters enclosed in brackets { } are commonly used abbreviations.

regenerative braking	The recovery of some fraction of the energy normally dissipated in friction braking into energy to be stored in an energy storage device. Also referred to as regen braking.
reversal	Forced discharge of a battery cell voltage below zero, that is, to the point that the cell's electrical terminals change polarity.
self-discharge	The process by which the available capacity of a battery is spontaneously reduced by undesirable chemical reactions or electronic short circuits within the cell.
separator	A cell component placed between the negative and positive electrodes that acts as an electronic insulator and physical separator. The electrolyte (ionic conductor) may also act as a separator.
service life	A general term that describes the length of time a battery can remain in service. Normally, the service life consists of calendar and/or cycle life.
short-circuit current (A)	That current delivered when a battery is short-circuited (i.e., the positive and negative terminals are directly connected with a low-resistance conductor).
specific energy (Wh/kg)	The discharge energy capacity of the battery divided by the total battery weight. Varies with discharge conditions.
specific peak power (W/kg)	The peak power of the battery divided by the total battery weight. Other common (and similarly derived) terms include specific peak power and specific continuous power.
specific power (W/kg)	The rated power of the battery divided by the total battery weight. Occasionally, referred to as gravimetric power density.
state-of-charge {SOC} (%)	The ratio of the Ampere-hours remaining in a battery at a given rate to the rated capacity under the same specified conditions (SOC = 100% – DOD).
temperature coefficient of capacity	The ratio of the change in available capacity because of a battery temperature change relative to the available capacity at a specified temperature.
thermal loss (W/kWh)	The power required to maintain a battery at its specified operating temperature, normalized by the battery's rated energy capacity.
throughput (Wh)	Cumulative, net energy output provided by a battery over its service life. It is the sum of all the energy delivered over all the discharges that the battery has provided.
trickle charge	Low-rate charging current applied to a battery to maintain full charge.
utilization (%)	The percentage by weight of the limiting active material present in an electrode that is electrochemically available for discharge at useful voltages. It is equal to the actual capacity divided by the theoretical capacity.

Terms marked with an asterisk (*) are ambiguous; their use is discouraged.
Letters enclosed in brackets { } are commonly used abbreviations.

APPENDIX G

USABC CRITERIA FOR ADVANCED BATTERY TECHNOLOGIES

USABC Primary Criteria for Advanced Battery Technologies

Parameter	Mid Term	Long Term	Test Proc #	Test Unit Type*
Power Density W/L	250	600	3	C,M,P
Specific Power (Discharge) W/kg (80% DOD/30 sec)	150 (200 desired)	400	3	C,M,P
Specific Power (Regen) W/kg (20% DOD/10 sec)	75	200	12	C,M,P
Energy Density W·h/L (C/3 Discharge Rate)	135	300	2,5B	C,M,P
Specific Energy W·h/kg (C/3 Discharge Rate)	80 (100 desired)	200	2,5B	C,M,P
Life (Years)	5	10	Correlate from 14	C,M,P
Cycle Life (Cycles) (80% DOD)	600	1,000	14	C,M,P
Power & Capacity Degradation (% of rated spec)	20%	20%	14C	C,M,P
Ultimate Price (\$/kW·h) (10,000 units @ 40 kW·h)	<\$150	<\$100	---	---
Operating Environment	- 30 to 65°C	-40 to 85°C	9	C,M,P
Normal Recharge Time	<6 hours	3 to 6 hours	11	C,M,P
Fast Recharge Time	40-80% SOC in <15 minutes	40-80% SOC in <15 minutes	12	C,M,P
Continuous Discharge in 1 hour (no Failure)	75% (of rated energy capacity)	75% (of rated energy capacity)	4	C,M,P

* C = cell, M = module, P = pack

USABC Secondary Criteria for Advanced Battery Technologies

Parameter	Mid Term	Long Term	Test Proc #	Unit Type*
Efficiency (C/3 discharge 6 hour charge)	75%	80%	2	C
Self-Discharge	<15% in 48 hours	<15% per month	7	C
Maintenance	No Maintenance (service by qualified personnel only)	No Maintenance (service by qualified personnel only)	---	---
Thermal Loss (for high temperature batteries)	3.2 W/kWh 15% of capacity 48-hour period	3.2 W/kWh 15% of capacity 48-hour period	7	P
Abuse Resistance	Tolerant (minimized by on-board controls)	Tolerant (minimized by on-board controls)	13	P
OTHER CRITERIA				
Recyclability - 100%				
Packaging Constraints				
Environmental Compliance (manufacturing process, transport, in use and recycling)				
Reliability (tie to Warranty and cycle life)				
Safety			13	C,P
Vibration Tolerance			10	C,P

* C = cell, M = module, P = pack

APPENDIX H

PROCEDURE TO MEASURE ACTUAL PEAK POWER

APPENDIX H

Procedure to Measure Actual Peak Power

Purpose:

The purpose of this test is to measure the actual capability of a battery to deliver sustained power for 30 second intervals at one or more depths-of-discharge (DODs). It should be noted that this test will load the battery with discharge currents that will depress its voltage to 2/3 or less of the open circuit value. Depending on the battery design, this may require extremely high currents and may be damaging to the battery. A more detailed procedure for the conduct of this test can be obtained on request from the Idaho National Engineering Laboratory.

Abstract:

Charge the battery, allow it to stand for one hour at open circuit, and discharge it to the intended DOD at a constant current of $C_3/3$ amperes. Interrupt the $C_3/3$ discharge and determine the open circuit voltage (OCV) at this DOD. Sweep the discharge current (in approximately 5 seconds or less) to a value that reduces the battery terminal voltage to less than 2/3 of its open circuit value at this DOD; then immediately return the discharge current to zero at the same sweep rate. From a graph of the voltage vs current during the (increasing) sweep, determine the current corresponding to 2/3 OCV at the given DOD; this current will be used as the test current for the subsequent peak power test. The $C_3/3$ discharge can be continued and additional sweeps made at other DODs to determine the appropriate test currents for these DODs.

Recharge the battery, wait one hour at open circuit, and discharge the battery to the intended DOD at $C_3/3$. Then discharge the battery at the previously determined test current for 30 seconds while recording voltage as a function of time. The peak power available from the battery is defined as the product of the 30 second sustained current and the time-averaged voltage over the 30 second discharge step. This $C_3/3$ discharge can also be continued to other DODs and additional 30 second discharges can be done using the test current previously determined for each DOD.

This test should normally be repeated at least once, i.e. performed a total of two or more times.

Data Acquisition and Reporting Requirements:

Data to be acquired includes battery ampere-hours to each DOD at which testing is conducted, battery temperature at each DOD, voltage as a function of current at each of the initial sweeps, and voltage as a function of time during each of the 30 second discharge steps. Additional summary information to be reported should include a plot of peak power vs depth of discharge.

APPENDIX I

DERIVATION OF USABC BATTERY PEAK POWER CALCULATIONS

Appendix I

Derivation of USABC Battery Peak Power Calculations

Model

A battery is assumed to be representable as shown in Figure 1, as an ideal battery with a series resistance R . Discharge current is considered to have a negative sign, i.e. current into the battery is positive. This is a common although not universal convention among battery testing laboratories, and it has been adopted as the standard for USABC testing to assure consistency. This convention means that **all** discharge quantities (power, energy, capacity etc.) will be algebraically **negative**. This may seem counterintuitive, but in fact the common understanding of “discharge power” and “charge/regen power” is that these are “sign less” quantities where only their magnitude is of interest; the fact that they have opposite signs is expressed in the “discharge” and “charge” labels.

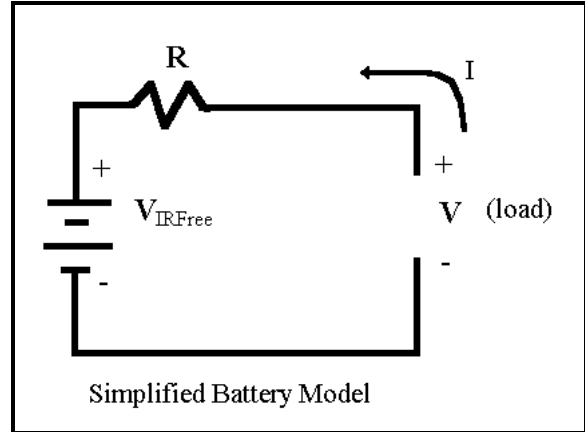

Figure 1

Resistance

For purposes of estimating peak (discharge) power capability at a given depth of discharge, a 'dynamic' resistance is determined based on a measurement of $\Delta V/\Delta I$ between a base current and a high current step. The changes in voltage and current are measured from a point in time just before the beginning of a 30 second current pulse to a point near the end of the 30 second pulse, as shown in Figure 2.

The resulting resistance value is calculated as:

$$R = \Delta V / \Delta I = (V_1 - V_2) / (I_1 - I_2)$$

The numeric value of R is always positive because the value of I (by convention) is negative.

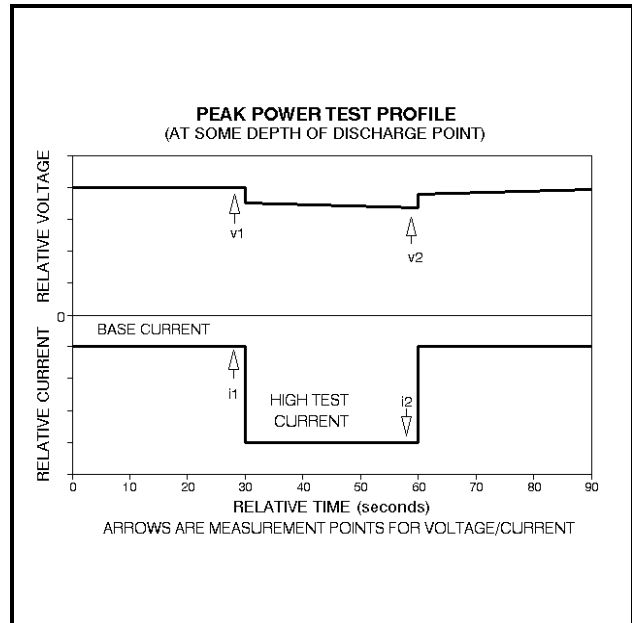

Figure 2

$I_{r_{free}}$ Voltage

An estimate of open circuit voltage, called ' $I_{r_{free}}$ Voltage', is derived by extrapolating the resistance (i.e. the $\Delta V/\Delta I$ behavior) back to zero current at the pulse test conditions:

$$V_{IRFree} = V - IR$$

where either V,I pair (V_1, I_1) or (V_2, I_2) can be used for the calculation. The sign of the IR term must be negative, again because current out of the battery has a negative sign.

Peak Power Capability

By USABC convention, peak power is the maximum discharge power which a battery can produce into a load for 30 seconds (at a given depth of discharge) without allowing the voltage to drop below 2/3 of its open circuit value (OCV) at that DOD. The discharge voltage is also restricted to be above a Discharge Voltage Limit (DVL), which is determined as the higher of (a) 2/3 of OCV at 80% DOD at beginning of life or (b) the manufacturer specified minimum discharge voltage. Limiting the voltage under load to 2/3 OCV or the DVL is done for efficiency and propulsion system design considerations. This means the resulting battery peak power capability is less than the theoretical maximum, which would occur for a load that depressed the voltage to 1/2 OCV. The USABC peak power capability is **calculated** (not measured) based on the voltage and current deliverable to the load as follows:

$$\text{Power}_{load} = \text{Voltage}_{load} * \text{Current}_{load}$$

For the USABC peak power conditions, using the resistance and $I_{r_{free}}$ voltage,

$$\begin{aligned} \text{Voltage}_{load} &= 2/3 * V_{IRFree} \\ \text{Current}_{load} &= - (1/3 * V_{IRFree}) / R \end{aligned}$$

$$\text{Peak Power Capability} = (- 2/9) * (V_{IRFree}^2) / R \quad (1)$$

Because the OCV (at depths of discharge greater than 80% or late in life) may sometimes be less than the value at 80% DOD at beginning-of-life, it is also necessary to determine the power which may be delivered without dropping below the Discharge Voltage Limit (DVL). If this value is less than that calculated in equation (1), it becomes the Peak Power Capability instead. Without this restriction, the power calculated in (1) might be obtainable only at an unusably low voltage. This calculation is:

$$\begin{aligned} \text{Voltage}_{load} &= \text{DVL} \\ \text{Current}_{load} &= - (V_{IRFree} - \text{DVL}) / R \end{aligned}$$

$$\text{Peak Power Capability} = - \text{DVL} * (V_{IRFree} - \text{DVL}) / R \quad (2)$$

An additional constraint is placed on the calculated peak power capability by requiring that it must not be a value that would exceed the manufacturer's Maximum Rated Current for the battery. An alternative value based on this Maximum Rated Current, I_{MAX} , is calculated as:

$$\text{Peak Power Capability} = I_{MAX} * (V_{IRFree} + R * I_{MAX}) \quad (3)$$

The $V + RI$ term in this equation is the estimated load voltage at I_{MAX} , because V_{IRFree} is the “effective” open circuit voltage at the given depth of discharge.

As a final constraint, if voltage or current limiting is encountered during a given step, this means that the battery is not capable of sustaining the test current for 30 seconds at this depth-of-discharge without exceeding either I_{MAX} or its minimum voltage. In this case, the actual power measured at the end of the step is reported as the Peak Power Capability. The actual 30 second sustained power achievable at this point may be slightly larger than this value (because the step may have started at a higher power), but the exact value cannot be determined without additional tests; hence this value is **defined** as the Peak Power Capability under these conditions.

The most restrictive value resulting from equations (1), (2) or (3) is reported as the Peak Power Capability unless voltage or current limiting occurs. Note that equations (1) and (2) are equivalent at 80% DOD at beginning of life, and equation (3) only applies if the manufacturer has chosen to restrict the maximum discharge current.

Base Discharge Rate

The base discharge rate is chosen as a current which will make the average discharge current for the entire test equal to the C/3 discharge rate. This can be calculated by setting the coulombs (i.e. ampere-seconds) of charge removed in a complete C/3 discharge (lasting 3 hours, or 10,800 seconds) equal to that removed by the combined Base Discharge and High Test Current portions of the Peak Power Test presuming it lasts for 3 hours total also as follows:

$$(\text{coulombs in C/3 discharge}) = (\text{coulombs in Peak Power discharge})$$

$$(C_{rated} \div 3) \cdot 10800 = I_{base\ discharge} \cdot (10800-300) + (I_{high\ test\ current} \cdot 300)$$

C_{rated} is the ampere-hour capacity, and $(C_{rated} \div 3)$ is the 3-hour discharge current. Thus the units on both sides of this equation are ampere-seconds. Note that the total duration of the ten high current steps in a peak power test is 300s, leaving 10,500s for the base discharge portion of the test. Solving this equation for $I_{base\ discharge}$ gives the equation in the procedure:

$$I_{base\ discharge} = (12 \cdot C_{rated} - I_{high\ test\ current}) \div 35$$

APPENDIX J

DETAILED PROCEDURES

Procedures Included in Appendix J

Procedure Number	Procedure Name	Page
3	Peak Power Test	J-3
5A	FUDS Cycle Test	J-8
5B	Dynamic Stress Test (DST)	J-20
6	Partial Discharge Test	J-25
7	Stand Test	J-28
9	Thermal Performance Test	J-31
10	Battery Vibration Test	J-34

Peak Power Test

1.0 PURPOSE

The purpose of this test is to determine the maximum sustained power capability of a battery for 30 second discharge pulses at various depths of discharge (DOD). The value calculated at 80% DOD is particularly important because this is the point at which the USABC power goal is defined, and the technology performance at this point is compared with this goal. This procedure does **not** measure the actual peak power of the battery; rather it infers (calculates) a predicted peak power performance from measurements taken at high currents which are nonetheless lower than the rated peak power.

2.0 PREREQUISITES

2.1 A battery test plan or other test requirements document is required for testing using this procedure. The test plan specifies certain values to be used for this test. These values include the manufacturer's rated peak power at 80% DOD, minimum discharge voltage, maximum rated current (if any), rated A·h capacity, and test temperature limitations, along with safety precautions and any special handling/testing instructions specified for the battery by the manufacturer and/or the USABC.

2.2 Prior to the performance of this procedure, USABC Test Procedures No. 1A, Battery Pre Test Preparation, and No. 1B, Readiness Review, should normally have been completed. These activities are not a part of this procedure. This procedure may be executed as a stand-alone test activity or as part of a sequence of tests (e.g. periodic testing during a life-cycle test regime) provided that the information required by 2.1 above is available.

3.0 TEST EQUIPMENT

The equipment required to perform the peak power test consists of (a) a suitable charger for the battery; (b) a battery discharge tester capable of achieving the currents defined in 4.1.2 and 4.1.3; and (c) a data system capable of acquiring the data specified in Section 6.0 at intervals of 1 second or less. The maximum permissible transition time between current steps is 1 second or less. The transition times are included in the overall profile length (i.e. a High Test Current Step is always 30 seconds long.)

4.0 DETERMINATION OF TEST CONDITIONS

4.1 Calculate the Test Currents for the test as follows. (An example of these calculations is contained in the box following.) **Note: all current, power and ampere-hour values in calculations for this procedure use the convention that current (and thus power) out of the battery is negative.**

- 4.1.1 **Rated Peak Current** = Rated Peak Power (at 80% DOD) divided by 2/3 of the Open Circuit Voltage (at 80% DOD at beginning of life.)
- 4.1.2 **High Test Current** = the lesser [in magnitude] of (a) the manufacturer's Maximum Rated Current for the battery or (b) 80% of Rated Peak Current.
- 4.1.3 **Base Discharge Rate** = that current which, combined with a High Test Current 30 second pulse every 10% DOD, gives an average discharge current equivalent to the C/3 discharge rate. This can be calculated as follows:

$$I_{\text{base discharge}} = (12 \cdot C_{\text{rated}} - \text{High Test Current}) \div 35.$$

Note: If the capacity of the battery is so small that the Base Discharge Current would be zero or less (i.e. the pulse alone is 10% DOD or more), the test cannot be performed without modifying this procedure.

Example: Suppose Maximum Rated Current (for 30 s) = -250 A
 Rated Peak Power at 80% DOD = -16.0 kW
 Open Circuit Voltage (OCV) at 80% DOD = 120V
 C/3 Rated Capacity = -120 Ah

Then:

$$\text{Rated Peak Current} = -16.0 \text{ kW} \div (2/3 \text{ of } 120 \text{ V}) = -200 \text{ A}$$

High Test Current = the lesser (in magnitude) of

- a. -250 A
- b. 80% of -200 A

High Test Current = -160 A

$$\text{Base Discharge Rate} = (12 \cdot -120 - (-160)) \div 35$$

Base Discharge Rate = -36.57 A

Since 10% DOD should require 3 hours \div 10 = 1080 seconds, at an average current of 120 A \cdot h \div 3 hr = 40 A, this is 43,200 A-s per 10% DOD. During each 10% DOD, there is one 30 second pulse at the High Test Current of 160 A. This accounts for $(30 \cdot 160) = 4800$ A-seconds, leaving 38,400 A-seconds for the Base Discharge Rate over the remaining 1050 seconds. $38,400 \text{ A-s} \div 1050 \text{ s} = 36.57 \text{ A}$.

- 4.2 Establish the **Discharge Voltage Limit** for the battery as the greater of (a) the manufacturer's minimum voltage limit, or (b) 2/3 OCV at 80% DOD at beginning of life. If this value is not supplied by the manufacturer, it can be measured using a C/3 discharge terminated at 80% of rated capacity; the battery voltage at 1 hour after it is placed on open circuit at this condition will be considered the OCV.

5.0 PROCEDURE STEPS

- 5.1 Charge the battery in accordance with the test plan.
- 5.2 Conduct the Discharge
- 5.2.1 Discharge the battery at the Base Discharge Rate for 30 seconds.
- 5.2.2 Discharge the battery at the High Test Current for 30 seconds.
- 5.2.3 Continue to discharge the battery at the Base Discharge Rate until a 10% increment of the rated capacity (in A-h) has been removed, including the pulse in Step 5.2.3 (i.e. the capacity removed in the pulse plus the additional discharge at the Base Discharge Rate should be 10% DOD.)
- 5.2.4 Repeat 5.2.2 and 5.2.3 for each 10% DOD increment until 90% DOD is reached. When the 30 second discharge pulse is performed at 90% DOD, the Base Discharge Rate should continue for the remaining capacity of the battery.
- 5.3 Recharge the battery in accordance with the Test Plan.
- 5.4 Calculate the Peak Power capability of the battery at each 10% DOD increment.
- 5.4.1 Using the voltage and current measured (1) near the end of each High Test Current step and (2) just prior to the beginning of that step, calculate the battery resistance as the quotient of the voltage change and the current change between these two points:
- $$\text{Resistance } R = \Delta V \div \Delta I$$
- 5.4.2 Calculate the battery IR-free voltage (i.e. open-circuit voltage at this depth-of-discharge) from the voltage and current measured near the end of the High Test Current step:
- $$\text{Battery IR}_{\text{Free}} \text{ Voltage: } V_{\text{IRFree}} = V - IR$$
- 5.4.3 Calculate the Peak Power capability at this depth-of-discharge as the minimum value of the following three equations:
- (1) Peak Power Capability = $-(2/9) \cdot (V_{\text{IRFree}}^2) \div R$
- or
- (2) Peak Power Capability = $-DVL \cdot (V_{\text{IRFree}} - DVL) \div R$
- where DVL is the Discharge Voltage Limit

or

$$(3) \quad \text{Peak Power Capability} = I_{\text{MAX}} \cdot (V_{\text{IRFree}} + R \cdot I_{\text{MAX}})$$

where I_{MAX} is the Manufacturer's Maximum Rated Current (if defined, otherwise ignore this calculation)

See the example which follows for more information.

Example: (based on earlier example battery at 80% DOD)

Suppose Current near end of High Test Current step = -160 A
Voltage near end of High Test Current step = 88 V

Current 30 seconds earlier (Base Current) = -35 A
Voltage 30 seconds earlier (Base Current) = 113 V

Then $R = \Delta V \div \Delta I = (88 - 113) \div (-160 - (-35)) = 0.2 \text{ ohms}$

$$V_{\text{IRFree}} = 88 - (-160 \cdot 0.2) = 120 \text{ Volts}$$

Equation 1: Peak Power = $-(2/9) \cdot (120)^2 \div 0.2 = -16,000 \text{ W}$

NOTE: negative sign on discharge current is required for correct result

Equation 2: DVL = $2/3 \text{ OCV at } 80\% \text{ DOD} = 120 \cdot 2/3 = 80\text{V}$

$$\text{Peak power} = -80 \cdot (120 - 80) \div 0.2 = -16,000 \text{ W}$$

Equation 3: Peak Power = $(-250 \text{ A}) \cdot (120 \text{ V} + 0.2 \text{ S} \cdot -250 \text{ A}) = -17,500 \text{ W}$

Thus

Peak Power Capability = -16,000 Watts

5.4.4 If voltage or current limiting (due to minimum voltage or maximum current limits) was encountered during a High Test Current step, the Peak Power Capability is still calculated as above. However, if the actual power at the end of a 30 second step (where voltage or current limiting occurs) is less than the value calculated, this lower actual power must be reported as the Peak Power Capability. The High Test Current for subsequent steps during this discharge may (depending on equipment capabilities) be reduced to a value that will permit the step to be done at constant current (i.e. a value that does not result in further voltage limiting.)

5.4.5 If the Base Discharge Rate cannot be achieved at any point during the discharge without

dropping below the Discharge Voltage Limit, the discharge is terminated.

6.0 DATA ACQUISITION

6.1 Current Step Data

Battery current and voltage measurements must be taken at 1 second intervals for the period from 30 seconds before the start of each High Test Current step to 30 seconds after the completion of each High Test Current step. This is an interval of 90 seconds during each 10% DOD. These measurements should be preserved for subsequent analysis; and the 90 seconds of data nearest 80% DOD should be reviewed graphically to assure that the test results are valid.

6.2 Base Discharge Data

During the remainder of the discharge at the Base Discharge Rate, all measurements (voltage, current, temperature, module voltages if any etc.) must be recorded at intervals not exceeding 10 minutes or whenever any parameter (including % DOD) changes by 2% or more from the previous recorded value.

6.3 Data Averaging for Calculation

The two voltage-current measurement pairs used for calculating the peak power capability at each 10% DOD are normally obtained by (1) averaging three successive current and voltage measurements near the end of the High Test Current step and (2) averaging three successive current and voltage measurements just prior to the start of the step.

7.0 REPORTING

The calculated peak power capability at each 10% DOD interval should be reported and graphed against the actual (not nominal) depth of discharge corresponding to the end of the High Test Current step. A plot of current and voltage during the step closest to 80% DOD should also be provided.

FUDS Cycle Test

1.0 PURPOSE

For simulated driving cycle testing of USABC batteries, a variable power discharge cycle based on the Federal Urban Driving Schedule (FUDS) may be applied to the battery. The USABC FUDS is scaled to a percentage of the maximum rated power or USABC power goal for a given technology. In general the FUDS maximum power is likely to be 80% of the USABC peak power goal for a technology; however, the specific value to be used in this procedure is specified (in watts or kilowatts) in the test plan.

Figure 5A-1 shows a graphical representation of the USABC FUDS 1372 second test profile, which is applied repetitively over a complete battery discharge. Table 5A-1 is the tabular listing of the USABC FUDS power profile; this listing may be obtained in computer readable form from the Idaho National Engineering Laboratory (208-526-1847).

Note: All references to the term 'battery' in this procedure refer to the unit to be tested, which may be a single cell, a multi-cell module, a battery pack, or a complete battery system.

2.0 PREREQUISITES

2.1 A Battery Test Plan or other test requirements document is required for testing using this procedure. The test plan specifies the values to be used for the FUDS. These values include battery Ah ratings, peak discharge power to be applied during FUDS testing, charge/discharge termination criteria, charging procedure, test temperature limitations, safety precautions, and any special handling/testing instructions specified by the manufacturer and/or the USABC.

2.2 Prior to the performance of this procedure, USABC Test Procedures No. 1A, Battery Pre Test Preparation, and No. 1B, Readiness Review, should normally have been completed. These activities are not a part of this procedure. This procedure may be executed as a stand-alone test activity or as part of a sequence of tests (e.g. a life-cycle test regime) provided that the information required by 2.1 above is available.

3.0 TEST EQUIPMENT

The equipment required to perform the FUDS consists of (a) a battery charge-discharge tester capable of achieving the scaled power-time profile shown in Figure 5A-1; and (b) a data system capable of acquiring the data specified in Section 6.0 at intervals of 1 second or less. The steps in this profile are only 1 second long, and the maximum permissible transition time between power steps is thus 1 second or less. The transition times are included in the overall profile length (i.e. a FUDS profile is always 1372 seconds long.)

4.0 DETERMINATION OF TEST CONDITIONS

- 4.1 Determine the **power levels** to be applied **for each step** of this FUDS procedure. The maximum power level (as specified in the test plan or other test requirements document) is the 100% level shown in Figure 5A-1, which occurs in Step 195 in Table 5A-1. The power levels of the remaining steps are then calculated using the percentage values in Table 5A-1.
- 4.2 Determine (from the test plan) the **ampere-hour capacity** to be used for this FUDS procedure. In general the FUDS is performed to 100% of the battery's rated capacity. However, some lesser value such as 80% of this capacity may be established for life cycle testing. The battery capacity to be used for discharge is based on net capacity removed (total A•h less regeneration A•h).
- 4.3 Establish the **battery limits** to be observed during the test. These should be specified in the test plan and will normally consist of some set of voltage, current, power and/or temperature limits which should not be exceeded for the battery. The tester should be programmed such that these limits are not permitted to be exceeded during the test.

A FUDS discharge will terminate whenever the specified power cannot be achieved for a given step without exceeding one of the battery limits. (If specifically required by the test plan, this condition may be violated by permitting, for example, reduced regen power under some conditions during a discharge. However, this will affect the reporting requirements of Section 7.0.)

5.0 PROCEDURE STEPS

- 5.1 Charging - Fully charge the battery in accordance with instructions given in the test plan.
- 5.2 Open Circuit After Charge - With the battery on open circuit, stabilize the battery temperature or other initial conditions as specified in the test plan.
- 5.3 Discharge - Discharge the battery using the FUDS power profile. Repeat the 1372 second FUDS segments end-to-end (i.e. with no rest period between profiles) until a termination condition is reached.
- 5.4 Termination - The discharge should terminate when either of the following conditions is reached: (a) the power achievable on any step (without violating any battery limits) is less than the specified value for that step; or (b) the specified net ampere-hour capacity of the battery is removed.
- 5.5 Recharge - Recharge the battery in accordance with the test plan.

6.0 DATA ACQUISITION

6.1 Acquisition Rates

Overall battery voltage, current and power are required to be measured at intervals not exceeding 1 second during the entire FUDS discharge, and net ampacity (ampere-hours) and net energy (watt-hours) should be accumulated based on at least this frequency of data acquisition. Other measurements required by the test plan (e.g. battery temperatures, the voltages of modules or cells within a multi-cell/module battery etc.) must be measured at least once per minute, including during the maximum discharge and maximum regen steps, unless termination criteria are based on their values, in which case they must also be measured at 1 second intervals.

6.2 Data Retention

6.2.1 Performance Testing

For a FUDS test conducted as a battery performance test, overall voltage, current, power, ampacity (ampere-hour) and energy (kilowatt-hour) values must be recorded and retained at 1 second intervals for the entire discharge. The value of all measured parameters must be recorded and retained at least once during the maximum discharge and maximum regen steps in each profile. (See Data Acquisition and Retention requirements section of the USABC procedures manual.)

6.2.2 Life Cycle Testing

If the FUDS is used as a repetitive life cycle test, the data required by 6.2.1 must be retained between successive executions of the Reference Performance Tests, until permission is received from the USABC Program Manager to discard it.

7.0 REPORTING

In addition to the summary information required from all USABC tests, the following specific information shall be reported for any FUDS discharge conducted as a performance test:

- a. The peak power to which the test was scaled
- b. Measured capacity of the battery
- c. If any limitations were placed on the discharge by battery limits in the test plan (e.g. regen current limits), the capacity achieved both with and without such limits in effect shall be reported
- d. The current, power and voltage during the first 300 seconds of the complete profile nearest to 80% DOD shall be graphed

For FUDS discharges conducted as part of a life-cycle test series, the capacities in (b) and (c) above shall be graphed as a function of cycle number over the course of the life test series. Periodic (i.e. monthly) progress reporting shall include the capacities at the start of life testing, the number of cycles performed to date, and the present capacities.

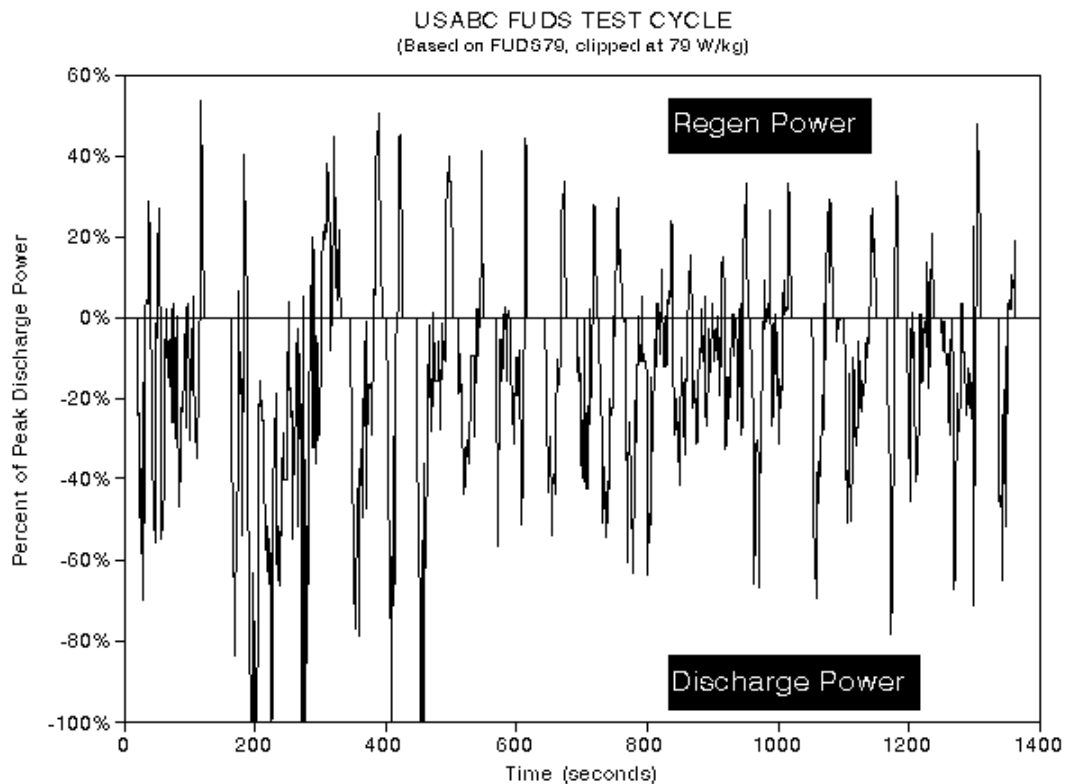

Table 5A-1
 USABC FUDS POWER PROFILE
 TIME (seconds) vs POWER (Fraction of Peak)

Time	Power	53	0.183544	107	-0.16456
0	0	54	0.103797	108	-0.22532
1	0	55	-0.04937	109	-0.30886
2	0	56	-0.4443	110	-0.31519
3	0	57	-0.54557	111	-0.34684
4	0	58	-0.52152	112	-0.28861
5	0	59	-0.52658	113	-0.20886
6	0	60	-0.38228	114	-0.0481
7	0	61	-0.21519	115	0.035443
8	0	62	-0.18481	116	0.535443
9	0	63	-0.13291	117	0.489873
10	0	64	0.018987	118	0.459494
11	0	65	-0.0557	119	0.389873
12	0	66	-0.14937	120	0.311392
13	0	67	-0.13165	121	0.229114
14	0	68	-0.05696	122	0
15	0	69	-0.0557	123	0
16	0	70	-0.09367	124	0
17	0	71	-0.25443	125	0
18	0	72	-0.25949	126	0
19	0	73	-0.13797	127	0
20	0	74	0.006329	128	0
21	-0.24051	75	0.032911	129	0
22	-0.23671	76	-0.13291	130	0
23	-0.38354	77	-0.22405	131	0
24	-0.46835	78	-0.3	132	0
25	-0.52911	79	-0.10253	133	0
26	-0.58481	80	0.005063	134	0
27	-0.15949	81	-0.23165	135	0
28	-0.23291	82	-0.29241	136	0
29	-0.6962	83	-0.3557	137	0
30	-0.32911	84	-0.46709	138	0
31	-0.26582	85	-0.3481	139	0
32	-0.11519	86	-0.29747	140	0
33	0.021519	87	-0.22532	141	0
34	0.044304	88	-0.22785	142	0
35	0.044304	89	-0.23165	143	0
36	0.031646	90	-0.12785	144	0
37	0.041772	91	-0.04051	145	0
38	0.287342	92	-0.08228	146	0
39	0.179747	93	-0.08228	147	0
40	-0.04557	94	-0.16835	148	0
41	-0.11519	95	-0.27089	149	0
42	-0.11772	96	0.018987	150	0
43	-0.1519	97	0.035443	151	0
44	-0.30127	98	0.018987	152	0
45	-0.5038	99	-0.22152	153	0
46	-0.55823	100	-0.3038	154	0
47	-0.51392	101	-0.26962	155	0
48	-0.13544	102	-0.19367	156	0
49	-0.01392	103	-0.17342	157	0
50	-0.0481	104	-0.08608	158	0
51	0.144304	105	0.035443	159	0
52	0.268354	106	0.053165	160	0

161	0	219	-0.51899	277	-0.67975
162	0	220	-0.58734	278	-1
163	0	221	-0.65823	279	-0.71266
164	-0.26329	222	-0.5481	280	-0.51519
165	-0.36203	223	-0.61772	281	-0.66076
166	-0.45949	224	-0.75443	282	-0.39367
167	-0.57089	225	-1	283	-0.27342
168	-0.71646	226	-0.98987	284	0.002532
169	-0.83671	227	-0.69367	285	0.043038
170	-0.73165	228	-0.57089	286	0.118987
171	-0.70633	229	-0.43924	287	0.198734
172	-0.55949	230	-0.31013	288	0.165823
173	-0.30506	231	-0.18734	289	-0.32152
174	0.068354	232	-0.36835	290	-0.32152
175	0.046835	233	-0.49873	291	-0.08101
176	0.018987	234	-0.57595	292	0.168354
177	-0.18608	235	-0.64937	293	-0.25696
178	-0.15443	236	-0.51772	294	-0.35823
179	-0.1557	237	-0.66329	295	-0.25696
180	-0.22785	238	-0.52911	296	-0.06456
181	-0.53797	239	-0.60886	297	-0.24937
182	0.06962	240	-0.47215	298	-0.29114
183	0.351899	241	-0.40633	299	-0.29114
184	0.153165	242	-0.28608	300	-0.05949
185	0.403797	243	-0.40253	301	0.003797
186	0.174684	244	-0.40253	302	0.005063
187	0.026582	245	-0.40253	303	0.13038
188	-0.2557	246	-0.40253	304	0.201266
189	-0.16962	247	-0.40253	305	0.2
190	-0.39241	248	-0.33544	306	0.229114
191	-0.66962	249	-0.21013	307	0.226582
192	-0.77215	250	-0.20633	308	0.196203
193	-1	251	0.039241	309	0.221519
194	-1	252	-0.05443	310	0.381013
195	-1	253	-0.11646	311	0.292405
196	-1	254	-0.2443	312	0.355696
197	-0.63291	255	-0.17468	313	0.250633
198	-1	256	-0.28987	314	0.21519
199	-0.75443	257	-0.55063	315	0.140506
200	-1	258	-0.42152	316	0.117722
201	-0.95823	259	-0.42278	317	-0.08354
202	-1	260	-0.35949	318	0.035443
203	-0.73038	261	-0.17595	319	0.132911
204	-0.68734	262	-0.10506	320	0.225316
205	-0.6481	263	-0.1038	321	0.394937
206	-0.26329	264	-0.09873	322	0.446835
207	-0.16076	265	-0.02658	323	0.149367
208	-0.21899	266	-0.51899	324	0.094937
209	-0.15696	267	-0.09114	325	0.040506
210	-0.25696	268	-0.26709	326	0.131646
211	-0.25696	269	-0.21772	327	0.120253
212	-0.25696	270	-0.21392	328	0.213924
213	-0.25696	271	-0.38354	329	0.096203
214	-0.37089	272	-0.27848	330	0
215	-0.37342	273	-1	331	0
216	-0.54557	274	0.053165	332	0
217	-0.61266	275	-1	333	0
218	-0.62532	276	-0.34937	334	0

335	0	393	0.155696	451	-0.57089
336	0	394	0	452	-0.71646
337	0	395	0	453	-0.83671
338	0	396	0	454	-1
339	0	397	0	455	-1
340	0	398	0	456	-0.5519
341	0	399	0	457	-0.54557
342	0	400	0	458	-1
343	0	401	0	459	-0.71139
344	0	402	0	460	-0.36203
345	0	403	-0.20886	461	-0.62152
346	0	404	-0.26709	462	-0.27215
347	-0.08354	405	-0.42658	463	-0.36456
348	-0.26582	406	-0.58101	464	-0.37215
349	-0.41772	407	-0.68481	465	-0.11646
350	-0.50633	408	-0.80633	466	-0.19494
351	-0.61519	409	-1	467	-0.1962
352	-0.70633	410	-0.89114	468	-0.06835
353	-0.6962	411	-0.29494	469	-0.01772
354	-0.76962	412	-0.71013	470	-0.28228
355	-0.42278	413	-0.61392	471	-0.16456
356	-0.5443	414	-0.46709	472	0.013924
357	-0.52532	415	-0.16582	473	-0.11266
358	-0.59241	416	-0.07975	474	-0.11139
359	-0.78734	417	0.002532	475	-0.06329
360	-0.40633	418	0.018987	476	-0.15823
361	-0.42025	419	0.035443	477	-0.15823
362	-0.32785	420	0.093671	478	-0.15823
363	-0.4	421	0.443038	479	-0.15823
364	-0.44051	422	0.453165	480	-0.15823
365	-0.4962	423	0.383544	481	-0.06203
366	-0.19873	424	0.305063	482	-0.2038
367	-0.26962	425	0.224051	483	-0.20506
368	-0.10759	426	0	484	-0.27722
369	-0.01266	427	0	485	-0.01519
370	-0.22532	428	0	486	-0.06203
371	-0.47342	429	0	487	-0.1557
372	-0.37089	430	0	488	-0.1557
373	-0.16456	431	0	489	-0.06076
374	-0.16456	432	0	490	-0.05949
375	-0.16456	433	0	491	-0.10506
376	-0.16456	434	0	492	0.150633
377	-0.16456	435	0	493	0.255696
378	-0.19494	436	0	494	0.329114
379	-0.28734	437	0	495	0.346835
380	-0.19873	438	0	496	0.372152
381	-0.12025	439	0	497	0.4
382	0.012658	440	0	498	0.332911
383	0.13038	441	0	499	0.332911
384	0.151899	442	0	500	0.268354
385	0.056962	443	0	501	0.170886
386	0.382278	444	0	502	0
387	0.416456	445	0	503	0
388	0.503797	446	0	504	0
389	0.368354	447	0	505	0
390	0.340506	448	-0.26329	506	0
391	0.307595	449	-0.36203	507	0
392	0.265823	450	-0.45949	508	0

509	0	567	0	625	0
510	0	568	0	626	0
511	-0.1	569	-0.26329	627	0
512	-0.18861	570	-0.36203	628	0
513	-0.16709	571	-0.45949	629	0
514	-0.09114	572	-0.56456	630	0
515	-0.28608	573	-0.33291	631	0
516	-0.17848	574	-0.32658	632	0
517	-0.16582	575	-0.27595	633	0
518	-0.25823	576	-0.05443	634	0
519	-0.39747	577	-0.05443	635	0
520	-0.43671	578	-0.15823	636	0
521	-0.40886	579	-0.1038	637	0
522	-0.34937	580	-0.05443	638	0
523	-0.33797	581	-0.0038	639	0
524	-0.30127	582	0.026582	640	0
525	-0.33418	583	-0.02911	641	0
526	-0.36203	584	0.007595	642	0
527	-0.31519	585	-0.15696	643	0
528	-0.29494	586	-0.08101	644	0
529	-0.21772	587	-0.02911	645	0
530	-0.13291	588	0.016456	646	-0.16203
531	-0.0962	589	-0.02785	647	-0.20506
532	-0.0962	590	-0.0519	648	-0.42911
533	-0.0962	591	-0.07722	649	-0.3481
534	-0.0962	592	-0.15696	650	-0.41139
535	-0.0962	593	-0.18228	651	-0.30127
536	-0.29494	594	-0.26203	652	-0.29241
537	-0.15949	595	-0.22405	653	-0.50127
538	-0.16076	596	-0.31392	654	-0.54051
539	0.018987	597	-0.27468	655	-0.41392
540	0.018987	598	-0.09873	656	-0.39367
541	-0.02025	599	-0.1	657	-0.38734
542	-0.0962	600	-0.19367	658	-0.43924
543	-0.0962	601	-0.18861	659	-0.33797
544	0.04557	602	-0.19241	660	-0.19114
545	0.155696	603	-0.11519	661	-0.23038
546	0.412658	604	-0.08101	662	-0.14177
547	0.332911	605	-0.08101	663	-0.14304
548	0.268354	606	-0.13418	664	-0.1038
549	0	607	-0.37468	665	-0.16456
550	0	608	-0.51266	666	-0.1443
551	0	609	-0.38228	667	-0.10506
552	0	610	-0.27089	668	0.032911
553	0	611	-0.26203	669	0.032911
554	0	612	0.1	670	0.25443
555	0	613	0.443038	671	0.281013
556	0	614	0.406329	672	0.335443
557	0	615	0.327848	673	0.197468
558	0	616	0.244304	674	0.156962
559	0	617	0	675	0.192405
560	0	618	0	676	0
561	0	619	0	677	0
562	0	620	0	678	0
563	0	621	0	679	0
564	0	622	0	680	0
565	0	623	0	681	0
566	0	624	0	682	0

683	0	741	-0.42405	799	-0.14557
684	0	742	-0.29747	800	-0.23924
685	0	743	-0.26962	801	-0.28101
686	0	744	-0.20253	802	-0.63797
687	0	745	-0.24177	803	-0.48481
688	0	746	-0.21013	804	-0.49494
689	0	747	-0.11266	805	-0.51392
690	0	748	0.003797	806	-0.14557
691	0	749	-0.06962	807	-0.36203
692	0	750	-0.02911	808	-0.30127
693	0	751	0.035443	809	-0.26329
694	-0.11519	752	0.065823	810	-0.1038
695	-0.15696	753	0.16962	811	-0.0557
696	-0.09747	754	0.26962	812	-0.1481
697	-0.17468	755	0.253165	813	-0.10127
698	-0.35063	756	0.293671	814	-0.00886
699	-0.34177	757	0.246835	815	0.035443
700	-0.4	758	0.131646	816	-0.1
701	-0.2557	759	0.168354	817	0.035443
702	-0.40759	760	0	818	0.035443
703	-0.12785	761	0	819	-0.09241
704	-0.00253	762	0	820	-0.00127
705	-0.0519	763	0	821	-0.08987
706	-0.42152	764	-0.01266	822	0.117722
707	-0.29747	765	0	823	0.053165
708	-0.28734	766	0	824	-0.07975
709	-0.42405	767	-0.24051	825	-0.12152
710	-0.35316	768	-0.26709	826	-0.12152
711	-0.08101	769	-0.44557	827	-0.12152
712	0.021519	770	-0.6	828	0.002532
713	-0.2557	771	-0.60506	829	-0.07722
714	-0.26329	772	-0.4038	830	-0.11899
715	-0.14051	773	-0.26076	831	-0.03418
716	0.102532	774	-0.32658	832	0.018987
717	0.091139	775	-0.35696	833	0.068354
718	0.113924	776	-0.3962	834	0.035443
719	0.278481	777	-0.41392	835	0.067089
720	0.274684	778	-0.63291	836	0.201266
721	0.205063	779	-0.57595	837	0.240506
722	0	780	-0.42152	838	0.220253
723	0	781	-0.27468	839	0.165823
724	0	782	-0.20633	840	0.131646
725	0	783	-0.30759	841	-0.06076
726	0	784	-0.11519	842	-0.28734
727	0	785	-0.11519	843	-0.27342
728	-0.01139	786	-0.07342	844	-0.19873
729	-0.21772	787	0.003797	845	-0.22532
730	-0.26709	788	-0.03038	846	-0.25443
731	-0.41646	789	-0.11013	847	-0.26203
732	-0.51013	790	-0.11013	848	-0.31899
733	-0.30127	791	-0.06962	849	-0.39747
734	-0.43671	792	0.051899	850	-0.41519
735	-0.47342	793	-0.06709	851	-0.29114
736	-0.43165	794	-0.10506	852	-0.1
737	-0.5443	795	-0.10506	853	-0.15823
738	-0.52405	796	-0.10506	854	-0.15949
739	-0.5	797	-0.10506	855	-0.16203
740	-0.40633	798	-0.10506	856	-0.29241

857	-0.20506	915	0.120253	973	-0.47975
858	-0.34051	916	0.149367	974	-0.2962
859	-0.1557	917	0.044304	975	-0.20759
860	-0.15696	918	-0.07215	976	-0.1519
861	-0.15696	919	-0.09873	977	-0.11266
862	-0.07468	920	-0.32658	978	-0.11266
863	0.111392	921	-0.31013	979	0.092405
864	0.051899	922	-0.27342	980	-0.02785
865	0.035443	923	-0.14557	981	0.005063
866	0.15443	924	-0.14684	982	0.020253
867	0.082278	925	-0.2519	983	0.005063
868	0.032911	926	-0.15316	984	0.032911
869	-0.18354	927	-0.13418	985	0.005063
870	-0.18734	928	-0.13544	986	0.032911
871	-0.22532	929	-0.15696	987	0.14557
872	-0.15823	930	0.006329	988	0.265823
873	-0.26709	931	-0.02025	989	0.032911
874	-0.31392	932	-0.0962	990	-0.07089
875	-0.28861	933	-0.0962	991	-0.15823
876	-0.20127	934	0.006329	992	-0.26835
877	-0.3	935	-0.01899	993	-0.22911
878	-0.30886	936	-0.01899	994	-0.01392
879	-0.17848	937	-0.09114	995	-0.08228
880	-0.07468	938	-0.1481	996	-0.13671
881	-0.07468	939	-0.25316	997	0.007595
882	-0.07342	940	-0.0962	998	-0.08228
883	0.020253	941	0.018987	999	-0.08228
884	0.020253	942	-0.09367	1000	-0.31139
885	-0.06962	943	0.032911	1001	-0.24051
886	-0.10886	944	-0.21392	1002	-0.28101
887	0.020253	945	-0.28734	1003	-0.15063
888	0.020253	946	-0.25949	1004	-0.18734
889	0.050633	947	0.032911	1005	-0.22532
890	-0.22785	948	0.122785	1006	-0.13797
891	-0.26835	949	0.265823	1007	-0.06076
892	-0.20127	950	0.224051	1008	0.032911
893	-0.16835	951	0.33038	1009	0.093671
894	-0.02911	952	0.263291	1010	0.018987
895	-0.16835	953	0.183544	1011	0.031646
896	-0.10886	954	0	1012	0.007595
897	-0.10886	955	0	1013	0.018987
898	0.003797	956	0	1014	0.034177
899	0.005063	957	0	1015	0.020253
900	0.035443	958	0	1016	0.113924
901	0.005063	959	0	1017	0.33038
902	-0.06582	960	-0.16203	1018	0.287342
903	-0.10506	961	-0.24304	1019	0.207595
904	-0.10506	962	-0.51392	1020	0
905	-0.02532	963	-0.55316	1021	0
906	-0.06329	964	-0.65823	1022	0
907	-0.1038	965	-0.52152	1023	0
908	0.005063	966	-0.31139	1024	0
909	0.005063	967	-0.39241	1025	0
910	-0.09873	968	-0.33924	1026	0
911	-0.19494	969	-0.30633	1027	0
912	-0.06203	970	-0.36203	1028	0
913	0.006329	971	-0.52785	1029	0
914	0.096203	972	-0.66835	1030	0

1031	0	1089	-0.01519	1147	0.124051
1032	0	1090	-0.0557	1148	0.160759
1033	0	1091	-0.05696	1149	0.191139
1034	0	1092	0	1150	0
1035	0	1093	-0.01519	1151	0
1036	0	1094	0	1152	0
1037	0	1095	0	1153	0
1038	0	1096	0	1154	0
1039	0	1097	0	1155	0
1040	0	1098	0	1156	0
1041	0	1099	0	1157	0
1042	0	1100	0	1158	0
1043	0	1101	-0.01139	1159	0
1044	0	1102	-0.04557	1160	0
1045	0	1103	-0.08608	1161	0
1046	0	1104	-0.16582	1162	0
1047	0	1105	-0.37848	1163	0
1048	0	1106	-0.43291	1164	0
1049	0	1107	-0.50633	1165	0
1050	0	1108	-0.2481	1166	0
1051	0	1109	-0.13671	1167	0
1052	0	1110	-0.34684	1168	0
1053	-0.1	1111	-0.49747	1169	-0.16962
1054	-0.22658	1112	-0.5038	1170	-0.26709
1055	-0.40127	1113	-0.32785	1171	-0.4038
1056	-0.49241	1114	-0.13038	1172	-0.55823
1057	-0.60127	1115	-0.1	1173	-0.66329
1058	-0.69367	1116	-0.10127	1174	-0.78481
1059	-0.38354	1117	-0.15696	1175	-0.68481
1060	-0.41646	1118	-0.2962	1176	-0.60633
1061	-0.51899	1119	-0.22911	1177	-0.23418
1062	-0.41013	1120	-0.31519	1178	0.031646
1063	-0.37975	1121	-0.29494	1179	0.031646
1064	-0.33038	1122	-0.25316	1180	0.308861
1065	-0.34304	1123	-0.05823	1181	0.336709
1066	-0.39114	1124	-0.05696	1182	0.272152
1067	-0.19241	1125	-0.1519	1183	0.179747
1068	-0.28734	1126	-0.22405	1184	0
1069	-0.27342	1127	-0.22785	1185	0
1070	-0.24177	1128	-0.16076	1186	0
1071	0.003797	1129	-0.23418	1187	0
1072	0.035443	1130	-0.15696	1188	0
1073	0.035443	1131	-0.19367	1189	0
1074	-0.10253	1132	-0.14051	1190	0
1075	0.06962	1133	-0.10253	1191	0
1076	0.246835	1134	-0.10253	1192	0
1077	0.259494	1135	-0.06329	1193	0
1078	0.105063	1136	-0.06329	1194	0
1079	0.087342	1137	-0.10127	1195	0
1080	0.291139	1138	0.005063	1196	0
1081	0.274684	1139	-0.06456	1197	-0.02025
1082	0.187342	1140	0.018987	1198	-0.10886
1083	0.062025	1141	0.032911	1199	-0.16582
1084	0.016456	1142	0.096203	1200	-0.2443
1085	0	1143	0.120253	1201	-0.45443
1086	0	1144	0.253165	1202	-0.37975
1087	0	1145	0.162025	1203	-0.20506
1088	0	1146	0.272152	1204	-0.06456

1205	0.012658	1263	-0.28861	1321	0
1206	-0.08354	1264	-0.10506	1322	0
1207	-0.09873	1265	0	1323	0
1208	-0.03924	1266	0	1324	0
1209	-0.20633	1267	0	1325	0
1210	-0.33544	1268	-0.16582	1326	0
1211	-0.36835	1269	-0.34684	1327	0
1212	-0.40886	1270	-0.5519	1328	0
1213	-0.33038	1271	-0.67215	1329	0
1214	-0.38861	1272	-0.63165	1330	0
1215	-0.2	1273	-0.43924	1331	0
1216	-0.15823	1274	-0.27722	1332	0
1217	-0.06962	1275	-0.18987	1333	0
1218	0.007595	1276	-0.3038	1334	0
1219	0.007595	1277	-0.26709	1335	0
1220	-0.16203	1278	-0.24177	1336	0
1221	-0.15823	1279	-0.21392	1337	0
1222	-0.12911	1280	-0.09241	1338	-0.12278
1223	-0.04051	1281	0.032911	1339	-0.26582
1224	-0.01013	1282	0.031646	1340	-0.44557
1225	-0.01013	1283	-0.08734	1341	-0.46709
1226	-0.07089	1284	-0.08734	1342	-0.41392
1227	-0.04051	1285	-0.08734	1343	-0.37595
1228	0.136709	1286	-0.08734	1344	-0.23924
1229	0.041772	1287	-0.08734	1345	-0.65316
1230	0.008861	1288	-0.24051	1346	-0.17722
1231	-0.17342	1289	-0.12658	1347	-0.35316
1232	-0.11899	1290	-0.21392	1348	-0.27848
1233	-0.12025	1291	-0.14937	1349	-0.07089
1234	0.03038	1292	-0.18608	1350	-0.51899
1235	0.208861	1293	-0.22405	1351	0.031646
1236	0.177215	1294	-0.15696	1352	0.021519
1237	0.182278	1295	-0.13797	1353	0.020253
1238	0	1296	-0.19494	1354	0.031646
1239	0	1297	-0.16203	1355	0.043038
1240	0	1298	-0.3481	1356	0.031646
1241	0	1299	-0.71266	1357	0.018987
1242	0	1300	0.224051	1358	0.103797
1243	0	1301	-0.68354	1359	0.087342
1244	0	1302	-0.15696	1360	0.078481
1245	0	1303	-0.07468	1361	0.073418
1246	0	1304	0.129114	1362	0.108861
1247	0	1305	0.478481	1363	0.188608
1248	0	1306	0.444304	1364	0
1249	0	1307	0.378481	1365	0
1250	0	1308	0.3	1366	0
1251	0	1309	0.217722	1367	0
1252	-0.08354	1310	0	1368	0
1253	-0.01266	1311	0	1369	0
1254	-0.01266	1312	0	1370	0
1255	-0.01266	1313	0	1371	0
1256	-0.01266	1314	0	1372	0
1257	-0.05696	1315	0		
1258	-0.11899	1316	0		
1259	-0.08987	1317	0		
1260	-0.08987	1318	0		
1261	-0.11392	1319	0		
1262	-0.23797	1320	0		

Dynamic Stress Test (DST)

1.0 PURPOSE

For simulated driving cycle testing of USABC batteries, a variable power discharge cycle called the Dynamic Stress Test (DST) will be applied to the battery. The DST is scaled to a percentage of the maximum rated power or USABC power goal for a given technology and requires higher regeneration levels than previous similar test cycles such as the Simplified Federal Urban Driving Schedule (SFUDS). In general the DST maximum power is intended to be 80% of the USABC peak power goal for a technology; however, the specific value to be used by this procedure is specified (in watts or kilowatts) as an input to this procedure.

Figure 5B-1 shows a graphical representation of the DST 360 second test profile, which is applied repetitively over a complete battery discharge. Table 5B-1 is the tabular listing of the DST power profile.

Note: All references to the term 'battery' in this procedure refer to the unit to be tested, which may be a single cell, a multi-cell module, a battery pack, or a complete battery system.

2.0 PREREQUISITES

2.1 A Battery Test Plan or other test requirements document is required for testing using this procedure. The test plan specifies the values to be used for the DST. These values include battery A·h ratings, peak discharge power to be applied during DST testing, charge/discharge termination criteria, charging procedure, test temperature limitations, safety precautions, and any special handling/testing instructions specified by the manufacturer and/or the USABC.

2.2 Prior to the performance of this procedure, USABC Test Procedures No. 1A, Battery Pre Test Preparation, and No. 1B, Readiness Review, should normally have been completed. These activities are not a part of this procedure. This procedure may be executed as a stand-alone test activity or as part of a sequence of tests (e.g. a life-cycle test regime) provided that the information required by 2.1 above is available.

3.0 TEST EQUIPMENT

The equipment required to perform the DST consists of (a) a battery charge-discharge tester capable of achieving the scaled power-time profile shown in Figure 5B-1; and (b) a data system capable of acquiring the data specified in Section 6.0 at intervals of 1 second or less. The maximum permissible transition time between power steps in this profile is 1 second, and these transition times are included in the overall profile length (i.e. a DST profile is always 360 seconds long.)

4.0 DETERMINATION OF TEST CONDITIONS

- 4.1 Determine the **power levels** to be applied **for each step** of this DST profile. The maximum power level (as specified in the test plan or other test requirements document) is the 100% level shown in Figure 5B-1, which occurs in Step 15 in Table 5B-1. The power levels of the remaining steps are then calculated using the percentage values in Table 5B-1.
- 4.2 Determine (from the test plan) the **ampere-hour capacity** to be used for this DST procedure. In general the DST is performed to 100% of the battery's rated capacity. However, some lesser value such as 80% of this capacity may be established for life cycle testing. The battery capacity to be used for discharge is based on net capacity removed (total A·h less regeneration A·h).
- 4.3 Establish the **battery limits** to be observed during the test. These should be specified in the test plan and will normally consist of some set of voltage, current, power and/or temperature limits which should not be exceeded for the battery. The tester should be programmed such that these limits are not permitted to be exceeded during the test. In the test plan does not include a manufacturer-specified minimum discharge voltage, the Discharge Voltage Limit shall be set to 2/3 of the open circuit voltage at 80% DOD (at beginning of battery life.) Voltage during any DST discharge step shall not be allowed to fall below the Discharge Voltage Limit.

A DST discharge will terminate whenever the specified power cannot be achieved for a given step without exceeding one of the battery limits. (If specifically required by the test plan, this condition may be violated by permitting, for example, reduced regen power at the beginning of a discharge. However, this will affect the reporting requirements of Section 7.0.)

5.0 PROCEDURE STEPS

- 5.1 Charging - Fully charge the battery in accordance with instructions given in the test plan.
- 5.2 Open Circuit After Charge - With the battery on open circuit, stabilize the battery temperature or other initial conditions as specified in the test plan.
- 5.3 Discharge - Discharge the battery using the DST power profile. Repeat the 360 second DST segments end-to-end (i.e. with no rest period between profiles) until a termination condition is reached.
- 5.4 Termination - The discharge should terminate when either of the following conditions is reached: (a) the power achievable on any step (without violating any battery limiting conditions) is less than the specified value for that step; or (b) the specified net ampere-hour capacity of the battery is removed.

- 5.5 Recharge - Charge the battery in accordance with the test plan.

6.0 DATA ACQUISITION

6.1 Acquisition Rates

Overall battery voltage, current and power are required to be measured at intervals not exceeding 1 second during the entire DST discharge, and net ampacity (ampere-hours) and net energy (watt-hours) should be accumulated based on at least this frequency of data acquisition. Other measurements required by the test plan (e.g. battery temperatures, the voltages of modules or cells within a multi-cell/module battery etc.) must be measured at least twice per DST profile during the maximum discharge and maximum regen steps (Steps 15 and 19 in Table 5B-1), unless termination criteria are based on their values, in which case they must also be measured at 1 second intervals.

6.2 Data Retention

6.2.1 Performance Testing

For a DST conducted as a battery performance test, overall voltage, current, power, ampacity (ampere-hour) and energy (kilowatt-hour) values must be recorded and retained for at least 2 points per step in each DST profile for the entire discharge, once near the beginning and once near the end of each step. The value of all measured parameters must be recorded and retained at least once during the maximum discharge and maximum regen steps in each profile. (See Data Acquisition and Retention requirements section of the USABC procedures manual.)

6.2.2 Life Cycle Testing

If the DST is used as a repetitive life cycle test, the data required by 6.2.1 must be retained between successive execution of the Reference Performance Tests, until permission is received from the USABC Program Manager to discard it.

7.0 REPORTING

In addition to the summary information required from all USABC tests, the following specific information should be reported for any DST discharge conducted as a performance test or a Reference Performance Test during life cycling:

- a. The peak power to which the test was scaled
- b. Measured capacity of the battery
- c. If any limitations were placed on the discharge by battery limits in the test plan (e.g. regen current limits), the capacity achieved both with and without such limits in

- effect should be reported
- d. The current, power and voltage during the complete profile nearest to 80% DOD should be graphed.

For DST discharges conducted as part of a life-cycle test series, the capacities in (b) and (c) above should be graphed as a function of cycle number over the course of the life test series. Periodic (i.e. monthly) progress reporting should include the capacities at the start of life testing, the number of cycles performed to date, and the present capacities.

TABLE 5B-1
DST POWER PROFILE TABULAR LISTING

Step Discharge No.	Duration (Seconds)	Discharge Power (%)	Step No.	Duration (Seconds)	Discharge Power (%)
1	16	0.0	11	12	-25.0
2	28	-12.5	12	8	+12.5
3	12	-25.0	13	16	0.0
4	8	+12.5	14	36	-12.5
5	16	0.0	15	8	-100.0
6	24	-12.5	16	24	-62.5
7	12	-25.0	17	8	+25.0
8	8	+12.5	18	32	-25.0
9	16	0.0	19	8	+50.0
10	24	-12.5	20	44	0.0

Note: Negative values represent discharge; positive values are regen.

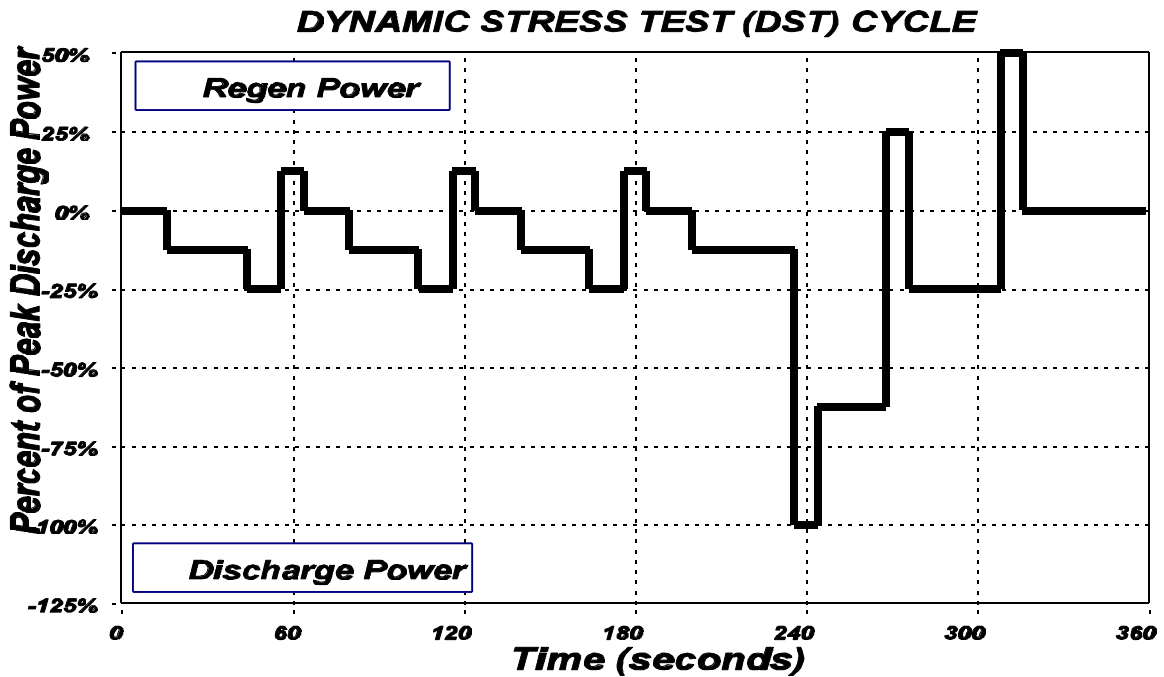

Figure 5B-1. DST Profile in Relative Power Units

Partial Discharge Test

1.0 PURPOSE

The purpose of this test is to measure the response of the battery to a series of partial discharges, identify any resulting capacity loss, and verify proper charging with partial depth-of-discharge (DOD) operation.

This test may be used either to determine the rate of capacity loss from a period of partial discharge operation or to verify that the loss is within acceptable USABC limits.

2.0 PREREQUISITES

2.1 A battery test plan or other test requirements document is required for testing using this procedure. The test plan specifies certain values to be used for this test. These values may include the number and type of partial discharges and the discharge termination conditions, along with safety precautions and any special handling/testing instructions specified for the battery by the manufacturer and/or the USABC.

2.2 Prior to the performance of this procedure, USABC Test Procedures No. 1A, Battery Pre Test Preparation, and No. 1B, Readiness Review, should normally have been completed. These activities are not a part of this procedure. This procedure may be executed as a stand-alone test activity or as part of a sequence of tests provided that the information required by 2.1 above is available.

3.0 TEST EQUIPMENT

The only equipment required for this procedure consists of a charge/discharge tester and data system capable of performing a constant-current (or other) discharge test as specified by the test plan.

4.0 DETERMINATION OF TEST CONDITIONS

4.1 Unless otherwise specified by the test plan, this test is performed at normal ambient temperature ($\sim 23^{\circ}\text{C} \pm 2^{\circ}\text{C}$).

4.2 Discharge termination conditions are generally the same as those for normal discharge tests. However, this test may be performed in two fundamentally different ways depending on the test plan objective.

4.2.1 The normal test method determines the **actual** capacity loss (if any) resulting from partial discharges. Using this method, the capacity must be measured to a predetermined condition (e.g. cutoff voltage) both before and after the partial discharge test series. In this case, the test plan should specify that testing is to be done to 100% of actual deliverable (not rated) capacity.

4.2.2 The alternate test method uses reference constant current discharges to 100% of the **rated** capacity of the battery, i.e. discharge terminates when the rated capacity has been removed even if no other discharge limiting condition has been reached. If this is done, no battery capacity loss will be observed unless the battery capacity drops below its rated value after the partial discharge tests. This method is used only to determine that an unacceptable capacity loss does not result from partial discharges.

4.3 This procedure is based on the use of C/3 constant current discharges for both the full and partial discharge portions of this test series. Use of another test profile such as the DST for the partial discharge cycles is permissible if specified in the test plan.

5.0 PROCEDURE STEPS

- 5.1 Fully charge the battery in accordance with manufacturer's recommendations or as specified in the test plan.
- 5.2 Discharge the battery fully using a C/3 constant current discharge as defined in USABC Procedure 2, using the specified termination conditions as defined in 4.2 above.
- 5.3 Fully charge the battery as in 5.1 above.
- 5.4 Repeat 5.1 through 5.3 twice (i.e. total of 3 full constant current discharge cycles.)
- 5.5 Perform a predetermined number of partial discharge cycles, normally 10 unless otherwise specified in the test plan.
 - 5.5.1 Discharge the battery for a predetermined fraction of its capacity (normally 50%, or as specified in the test plan) using a C/3 constant current discharge.
 - 5.5.2 Recharge the battery fully using the manufacturer's recommended procedure or as specified in the test plan. Battery current and voltage data acquired during recharge should be examined to determine that proper end-of-charge conditions are being achieved.
 - 5.5.3 Allow a stand interval of approximately one hour after each discharge and charge cycle.
- 5.6 Repeat the reference discharge test sequence 5.2 through 5.4 above to determine whether a capacity loss has occurred.
- 5.7 If a capacity loss (i.e. capacity in 5.2 minus capacity in 5.6) greater than 1% is observed, discharge the battery for additional cycles as necessary to achieve a stable capacity.

6.0 DATA ACQUISITION

There are no specific data acquisition requirements beyond those for normal constant current discharge tests. However, data acquisition rates during recharge should be adequate to allow analysis of the charge procedure with partial discharge operation.

7.0 REPORTING

- 7.1 In addition to the normal data reported for constant-current discharge tests, the immediate measured loss of capacity shall be reported. Because of the variability inherent in repeated discharge tests of the same type, a capacity loss (averaged over 3 cycles) of less than 1% may be reported as "less than 1%" rather than attempting to attach any significance to very low values.
- 7.2 Any permanent or long-term loss in capacity (i.e. persisting beyond the three cycles in 5.6) should also be noted. In this event the full-discharge capacity vs cycle should be reported so that the capacity recovery can be evaluated.
- 7.3 End-of-charge and end-of-discharge voltages vs cycle should be reported graphically for the entire test series encompassed by this procedure.
- 7.4 Reported results should specify whether the test was performed based on rated or deliverable capacity.

Stand Test

1.0 PURPOSE

The purpose of this test is to measure battery capacity loss when the battery is not used for an extended period of time, analogous to the situation that occurs when a vehicle is not driven for such a period and the battery is not placed on charge. This loss, if it occurs, may be due to self-discharge, which is normally temporary, or to other mechanisms that could produce permanent or semi-permanent loss of capacity. If significant stand loss is measured, additional testing may be required to determine the cause of this behavior.

This test may be used either to determine the rate of capacity loss on stand or to verify that the loss is within acceptable USABC limits.

2.0 PREREQUISITES

2.1 A battery test plan or other test requirements document is required for testing using this procedure. The test plan specifies certain values to be used for this test. These values may include the length of the stand period and the discharge termination conditions, along with safety precautions and any special handling/testing instructions specified for the battery by the manufacturer and/or the USABC.

2.2 Prior to the performance of this procedure, USABC Test Procedures No. 1A, Battery Pre Test Preparation, and No. 1B, Readiness Review, should normally have been completed. These activities are not a part of this procedure. This procedure may be executed as a stand-alone test activity or as part of a sequence of tests provided that the information required by 2.1 above is available.

3.0 TEST EQUIPMENT

The only equipment required for this procedure consists of a charge/discharge tester and data system capable of performing a constant-current discharge test in accordance with USABC Procedure 2.

4.0 DETERMINATION OF TEST CONDITIONS

4.1 Unless otherwise specified by the test plan, this test is performed at normal ambient temperature ($\sim 23^{\circ}\text{C} \pm 2^{\circ}\text{C}$).

4.2 Discharge termination conditions are generally the same as those for normal constant current discharge tests. However, this test may be performed in two fundamentally different ways depending on the test plan objective.

4.2.1 The normal test method determines the **actual** capacity loss rate on stand. Using this method, the battery must be discharged to a predetermined

condition (e.g. cutoff voltage) both before and after the stand time. In this case, the test plan should specify that testing is to be done to 100% of actual deliverable (not rated) capacity.

- 4.2.2 The alternate test method uses constant current discharges to 100% of the **rated** capacity of the battery, i.e. discharge terminates when the rated capacity has been removed even if no other discharge limiting condition has been reached. If this is done, no battery capacity loss will be observed unless the loss causes the battery capacity to drop below its rated value. This method is used only to determine that the stand loss does not result in unacceptable capacity loss during the stand period.

5.0 PROCEDURE STEPS

- 5.1 Fully charge the battery in accordance with manufacturer's recommendations or as specified in the test plan.
- 5.2 Discharge the battery using a C/3 constant current discharge as defined in USABC Procedure 2, using the specified termination conditions as defined in 4.2 above.
- 5.3 Fully charge the battery as in 5.1 above.
- 5.4 Allow the battery to stand at ambient temperature (or as specified in the test plan) for a period of 48 hours for midterm battery technologies or 30 days for long term technologies, or as specified in the test plan. Any external sources of parasitic energy losses during the stand period must be eliminated to the extent possible, including disconnection of measurement circuitry if leakage energy could be significant compared to the losses expected. If battery control systems or other external hardware must be powered during the stand period, this power should be provided from sources external to the battery; the energy consumed by such hardware over the stand period should be measured and reported separately.
- 5.5 At the end of the stand period, immediately discharge the battery using a C/3 constant current discharge under the same conditions as 5.2 above.
- 5.6 Recharge the battery as in 5.1 above.
- 5.7 If a capacity loss (i.e. capacity in 5.2 minus capacity in 5.5) greater than 2% is observed, discharge the battery for two additional cycles or as necessary to achieve a stable capacity.

6.0 DATA ACQUISITION

Data acquisition requirements are the same as those for normal constant current discharge tests, except that monitoring of parasitic energy losses during the stand period may be required for external hardware such as battery controllers or thermal management systems.

7.0 REPORTING

- 7.1 In addition to the normal data reported for constant-current discharge tests, the immediate measured loss of capacity shall be reported. Because of the variability inherent in repeated discharge tests of the same type, a capacity loss of less than 2% may be reported as "less than 2%" rather than attempting to attach any significance to very low values.
- 7.2 Any permanent or long-term loss in capacity (i.e. persisting beyond three cycles after the stand period) should also be noted. In this event the full-discharge capacity vs cycle should be reported so that the capacity recovery can be evaluated.
- 7.3 Parasitic energy losses (if any) measured during the stand period should be reported.
- 7.4 Reported results should specify whether the test was performed based on rated or deliverable capacity.

Thermal Performance Test

1.0 PURPOSE

The purpose of this test procedure is to characterize the effects of ambient temperature variation on battery performance. It can also be used to determine the need for thermal management or the allowable operating temperature range for a battery that may later incorporate thermal management.

This procedure is appropriate for determining ambient temperature effects on batteries without thermal management systems. Additional information may be required for systems-level testing.

2.0 PREREQUISITES

2.1 A battery test plan or other test requirements document is required for testing using this procedure. The test plan specifies certain values to be used for this test. These values may include the specific charge and discharge tests/procedures to be used, the temperature(s) at which charging and discharging are to be performed, and any limiting test conditions for the battery, along with safety precautions and any special handling/testing instructions specified by the manufacturer and/or the USABC.

2.2 Prior to the performance of this procedure, USABC Test Procedures No. 1A, Battery Pre Test Preparation, and No. 1B, Readiness Review, should normally have been completed. These activities are not a part of this procedure. This procedure may be executed as a stand-alone test activity or as part of a sequence of tests provided that the information required by 2.1 above is available.

3.0 TEST EQUIPMENT

Equipment required for the performance of this testing includes the following:

- 3.1 A battery charge-discharge tester capable of performing the specified discharge tests
- 3.2 An appropriate battery charger (which may be the tester itself)
- 3.3 An environmental chamber capable of heating and/or cooling the battery to the temperatures specified in the test plan
- 3.4 A data acquisition system capable of acquiring the data required for the specific discharge tests at the appropriate rate. (See the corresponding USABC procedure for these discharge tests for more information.)

4.0 DETERMINATION OF TEST CONDITIONS

4.1 References

- 4.1.1 USABC Test Procedure 2, Constant Current Tests
- 4.1.2 USABC Test Procedure 3, Peak Power Test
- 4.1.3 USABC Test Procedure 5B, Dynamic Stress Test

4.2 Discharge Conditions

This procedure is written to characterize battery performance based on the DST and the Peak Power Test; however, other discharge cycles may be used in addition to or in place of these two. In such cases the test plan must specify the discharge regime(s) to be used. The USABC procedure for the specific type(s) of discharge to be performed (e.g. FUDS, DST, constant current, constant power etc.) is used to determine the discharge conditions and limits (other than temperature) to be observed during this testing. Unless otherwise specified, the same termination conditions will be used at all temperatures.

4.3 Charge Conditions

The manufacturer's recommended charge method is to be used in conjunction with this procedure whenever possible. If the test plan requires charging to be done at high or low temperatures, rather than ambient temperature as specified in this procedure, the manufacturer should be consulted regarding modifications to the normal charge algorithm.

4.2 Temperature Conditions

The values specified in this procedure are selected based on the USABC performance requirements. If other values are to be used based on the development status of a technology, they must be specified directly in the test plan, including the temperatures to be used for charging and discharging, and the sequence of charge/discharge cycles to be performed at each temperature.

If the battery to be tested includes control or thermal management hardware, the test plan should specify whether this equipment is to be subjected to the same temperature regime as the battery itself.

5.0 PROCEDURE STEPS

- 5.1 At the nominal ambient temperature of $\sim 23^{\circ}\text{C}$, perform a sequence of Reference Performance Test discharges to a predetermined termination condition, using a C/3 constant current discharge (Reference 4.1.1), 100% DOD DST discharge (Reference 4.1.2) and peak power test (Reference 4.1.3) in that order.
- 5.2 Repeat 5.1 at the lowest specified temperature (normally -30°C .) Each discharge should be performed at the specified temperature, and the battery should then be returned to ambient temperature to be recharged (unless otherwise specified in the test plan.)
- 5.3 Repeat 5.1 at 0°C .
- 5.4 Repeat 5.1 at the highest specified temperature (normally 65°C .)
- 5.5 Repeat 5.1 at ambient temperature to determine whether off-normal temperature testing resulted in any change in battery performance at normal ambient temperature.
- 5.6 If a change of more than 5% in battery capacity or peak

power capability is observed in between the results of 5.1 and 5.5, the Reference Performance Tests should be repeated two additional times (3 total) at ambient temperature or as necessary to re-establish a stable capacity.

6.0 DATA ACQUISITION

In general the data acquisition requirements for this testing are the same as those for the same discharge tests conducted at ambient temperature.

- 6.1 Battery temperature sensors should be insulated from ambient air so that they will indicate the temperature of the battery component on which they are mounted.
- 6.2 Additional temperature measurements (beyond those used for ambient temperature testing) may be specified in the test plan, especially if a thermal management system is used.
- 6.3 If an active thermal management system is used, its power consumption must be monitored under charge, discharge and stand conditions at all test temperatures.

7.0 REPORTING

- 7.1 The normal data for the type of discharge(s) performed shall be provided.
- 7.2 Battery temperature shall be reported graphically as a function of time during discharge (and charge, if charging is done at other than normal ambient temperature) for each set of temperature conditions.
- 7.3 Any thermal management power consumption data acquired under 6.3 shall be reported as a function of temperature.
- 7.4 Any changes from the temperatures or discharge tests specified in this procedure should be specifically noted.

Battery Vibration Test

1.0 PURPOSE

This test is intended to characterize the effect of long-term, road-induced vibration and shock on the performance and service life of candidate batteries. Depending on the maturity of the battery, the intent of the procedure is either (a) to qualify the vibration durability of the battery or (b) to identify design deficiencies that must be corrected. Either swept sine wave vibration or random vibration can be used for the performance of this procedure, and separate sections are included for these alternatives.

For testing efficiency, a time-compressed vibration regime is specified to allow completion of the test in just over 24 hours of exposure per test article for swept sine wave excitation. For random excitation, the test regime requires a minimum of 13.6 hours and a maximum of 92.6 hours of testing, depending on the type of shaker table available and the choice of acceleration levels. The procedure has been synthesized from rough-road measurements at locations appropriate for mounting of traction batteries in EVs. The data were analyzed to determine an appropriate cumulative number of occurrences of shock pulses at any given G-level over the life of the vehicle. The envelopes shown in Figure 10-1 of the USABC Manual summary of this procedure (page 25, not repeated here) correspond to approximately 100,000 miles of usage at the 90th percentile. The vibration spectra contained in this procedure have been designed to approximate this cumulative exposure envelope.

This procedure describes the performance testing of a single test unit (battery, module or cell). For statistical purposes, multiple samples would normally be subjected to this testing. Additionally, some test units may be subjected to life cycle testing (either after or during vibration testing) to determine the effects of vibration on battery life. Such life testing is not described in this procedure.

2.0 PREREQUISITES

- 2.1 A battery test plan or other test requirements document is required for testing using this procedure. The test plan specifies the appropriate test conditions for the Reference Performance Tests and certain vibration frequencies to be used, along with safety precautions and any special handling/testing instructions specified for the battery by the manufacturer and/or the USABC.
- 2.2 Prior to the performance of this procedure, USABC Test Procedures No. 1A, Battery Pre Test Preparation, and No. 1B, Readiness Review, should normally have been completed. These activities are not a part of this procedure. This procedure may be executed as a stand-alone test activity or as part of a sequence of tests provided that the information required by 2.1 above is available.
- 2.3 Performance of the Reference Performance Tests specified in USABC Procedure 14C is required before and after the conduct of vibration testing. For completeness these are itemized within the procedure steps in Sections 5 and 6.

- 2.4 Unless otherwise specified, the test unit shall be tested early in its life (i.e. prior to the performance of any life cycle testing.)
- 3.0 TEST EQUIPMENT
- 3.1 A. Performance of the swept sine wave version of this procedure requires a single-axis shaker table capable of producing a peak acceleration of 5G within the range of 10 to 30 Hz, as well as G-loadings at the values and within the frequency ranges shown in Tables 1 and 2 following. (Note: if the unit to be tested can only be vibrated while in a particular physical orientation due to leakage or other constraints, a multi-axis table will be required.)
- B. Performance of the random vibration version of the procedure requires a one- to three-axis table capable of producing accelerations up to 1.9G over the vibration spectra detailed in Figure 2, extending from 10 to approximately 200 Hz. If the unit to be tested can only be vibrated while in a particular physical orientation, a multi-axis table will be required. Additionally, the time required to perform the test can be significantly reduced if the longitudinal and lateral axis vibration (or all three axes) can be performed concurrently.
- 3.2 Test fixtures are required to properly secure the test unit to the shaker table. The exact nature of these fixtures depends on the type of table used, the test unit itself, and any restrictions on physical orientation of the test unit.
- 3.3 Special instrumentation hookups capable of withstanding the vibration are required so that important battery conditions can be monitored during testing. (See Section 7.)
- 4.0 DETERMINATION OF TEST CONDITIONS AND TEST TERMINATION
- 4.1 Electrical test conditions are determined according to Procedure 14C, Reference Performance Tests.
- 4.2 The states-of-charge to be used for each vibration test regimes in Section 5 should be reviewed and adjusted for each specific battery technology (if necessary) to assure that a worst-case state-of-charge is used for each vibration regime.
- 4.3 The specific vibration frequencies for maximum vibration steps 5.3.2 and 5.5.2 should be specified in the test plan. If these are not specified, the vertical and longitudinal testing of 5.3.2 and 5.5.2 will be done at 15 and 12 Hz respectively. Other vibration test conditions are specified in the procedure steps in Sections 5 and 6.
- 4.4 Vibration testing shall be suspended or terminated if any observed component degradation threatens safe operation of the battery as specified by the manufacturer. Conditions to be monitored are defined in Section 7.
- 5.0 PROCEDURE STEPS FOR SWEPT SINE WAVE VIBRATION TESTING

- 5.1 Perform USABC Reference Performance Tests using Procedure 14C. This sequence includes a C/3 Constant Current discharge, a DST discharge to 100% of rated capacity, and a Peak Power discharge.
- 5.2 Charge the battery fully using the manufacturer's recommended charge method.
- 5.3 Vertical Axis Vibration (First Half at Full Charge)
 - 5.3.1 Mount the test unit so that it will be subjected to vibration in the vertical axis, based on the manufacturer's recommended physical orientation.
 - 5.3.2 Subject the test unit to 2000 sinusoidal cycles at 5 G peak acceleration, applied at a frequency to be specified in the test plan within the range from 10 Hz to 30 Hz.
 - 5.3.3 Subject the test unit to 60 sine sweeps from 10 Hz up to 190 Hz and back to 10 Hz, to be conducted at a sweep rate of 1 Hz/s for a total testing duration of 6 hours. The following profile of G-levels shall be used:

Table 1. Frequency and G-Values for Vertical Axis

Frequency Range (Hz)	Peak Acceleration (G)
10-20	3.0
20-40	2.0
40-90	1.5
90-140	1.0
140-190	0.75

- 5.4 Discharge the battery to approximately a 40% depth-of-discharge at the C/3 rate.
- 5.5 Longitudinal Axis Vibration (at 40% DOD)
 - 5.5.1 Mount the battery so that it will be subjected to vibration in the longitudinal axis, based on the manufacturer's recommended physical orientation.
 - 5.5.2 Subject the test unit to 4000 sinusoidal cycles at 3.5 G peak acceleration, applied at a frequency to be specified in the test plan within the range from 10 Hz to 30 Hz.
 - 5.5.3 Subject the test unit to 60 sine sweeps from 10 Hz up to 190 Hz and back to 10 Hz, to be conducted at a sweep rate of 1 Hz/s for a total test duration of 6 hours. The following profile of G-levels shall be used:

Table 2. Frequency and G-Values for Longitudinal Axis

Frequency Range (Hz)	Peak Acceleration (G)
10-15	2.5
15-30	1.75
30-60	1.25
60-110	1.0
110-190	0.75

- 5.6 Lateral Axis Vibration (at 40% DOD)
- 5.6.1 Mount the battery so that it will be subjected to vibration in the lateral axis (assumed to be orthogonal to the longitudinal axis), based on the manufacturer's recommended physical orientation.
- 5.6.2 Repeat 5.5.2 and 5.5.3 with the test unit mounted in this configuration.
- 5.7 Discharge the battery to approximately an 80% depth-of-discharge at the C/3 rate.
- 5.8 Vertical Axis Vibration (Second Half at 80% DOD)
- 5.8.1 Repeat 5.3.1 through 5.3.3 with the test unit at this reduced state of charge.
- 5.9 Repeat the USABC Reference Performance Tests using Procedure 14C. This sequence includes a C/3 Constant Current discharge, a DST discharge to 100% of rated capacity, and a Peak Power discharge.
- 6.0 PROCEDURE STEPS FOR RANDOM VIBRATION TESTING
- 6.1 Perform USABC Reference Performance Tests using Procedure 14C. This sequence includes a C/3 Constant Current discharge, a DST discharge to 100% of rated capacity, and a Peak Power discharge.
- 6.2 Charge the battery fully using the manufacturer's recommended charge method.
- 6.3 For each of the vertical, longitudinal and lateral axes of the battery, select either the normal or alternative G-levels from Table 3 and program the shaker table appropriately. This choice will determine the vibration time required for each axis, also in accordance with Table 3. (The vibration spectra, shown in Figure 1 following, are expressed in G^2/Hz , so they can be scaled for either set of G-levels.)

Table 3. Vibration Schedule for Random Vibration Test

TEST CONDITIONS		NORMAL TEST			ALTERNATIVE TEST		
VIBRATION SPECTRUM	SOC (%)	Accel (g rms)	Time (h)	Cumul Time, h	Accel (g rms)	Time (h)	Cumul Time, h
Vertical Axis Vibration:							
Vertical 1 spectrum	100	1.9	0.15	0.15	1.9	0.15	0.15
Vertical 1 spectrum	100	0.75	5.25	5.4	0.95	3.5	3.65
Vertical 2 spectrum	100	1.9	0.15	5.55	1.9	0.15	3.8
Vertical 2 spectrum	100	0.75	5.25	10.8	0.95	3.5	7.3
Vertical 3 spectrum	20	1.9	0.15	10.95	1.9	0.15	7.45
Vertical 3 spectrum	20	0.75	5.25	16.2	0.95	3.5	10.95
Longitudinal Axis Vibration:							
Longitudinal spectrum	60	1.5	0.09	16.29	1.5	0.09	11.04
Longitudinal spectrum	60	0.4	19.0	35.29	0.75	6.7	17.74
Longitudinal spectrum	60	1.5	0.09	35.38	1.5	0.09	17.83
Longitudinal spectrum	60	0.4	19.0	54.38	0.75	6.7	24.53
Lateral Axis Vibration:							
Longitudinal spectrum	60	1.5	0.09	54.47	1.5	0.09	24.62 ¹
Longitudinal spectrum	60	0.4	19.0	73.47	0.75	6.7	31.32 ¹
Longitudinal spectrum	60	1.5	0.09	73.56	1.5	0.09	31.41 ¹
Longitudinal spectrum	60	0.4	19.0	92.56	0.75	6.7	38.11 ¹

Note 1: These cumulative times apply only if all three axes are done separately.

- 6.4 Mount the test unit so that it will be subjected to vibration along the appropriate axes, based on the manufacturer's recommended physical orientation. This procedure permits the required vibration to be performed in one, two or all three axial directions simultaneously depending on the capabilities of the shaker table used (but see 6.4 for other considerations.)
- 6.5 Perform the programmed vibration for the required times, while battery depth-of-discharge is varied from 0% (full charge) to 80% (minimal charge) over the course of the vibration testing of a given battery. Two approaches are permitted to accomplish this:

(a) if a one- or two-axis vibration table is used, approximately half of the vertical axis testing should be done at full charge, followed by the longitudinal and lateral vibration at 40% DOD, and then the remaining vertical axis vibration at 80% DOD.

(b) If a three-axis table is used to perform all vibration regimes simultaneously, the total testing period can be divided into three intervals of roughly equal length. The first interval should be performed with the battery fully charged, the second interval with the battery at 40% DOD, and the third interval at 80% DOD.

- 6.6 Between each pair of the three intervals of vibration specified in 6.5, the battery should be discharged at a C/3 constant current rate for 40% of the rated capacity of the battery. Following the third vibration interval, the battery should be fully recharged.
- 6.7 Repeat the USABC Reference Performance Tests using Procedure 14C. This sequence includes a C/3 Constant Current discharge, a DST discharge to 100% of rated capacity, and a Peak Power discharge.

7.0 SAFETY CONSIDERATIONS FOR TESTING

During the application of the vibration regimes, the test unit shall be instrumented to determine the presence of any of the following conditions:

- 7.1 Loss of electrical isolation between the battery positive connection and the battery case and/or test equipment ground. The degree of isolation shall be verified regularly, e.g. daily, during any period of vibration testing to be within the USABC trial criterion of 0.5 **MS** or greater isolation (1.0 mA or less leakage at 500V DC).
- 7.2 Abnormal battery voltages indicating the presence of open- or short-circuit conditions.
- 7.3 Unexpected resonance conditions within the battery, indicating failure of mechanical tie-down components.
- 7.4 Abnormal temperature conditions indicating possible damage to battery cells or thermal management system components.

Detection of any of the conditions listed in 7.1 through 7.4 shall cause testing to be suspended until the condition has been evaluated and a determination has been made that either it is safe to proceed or the testing should be terminated.

8.0 DATA ACQUISITION AND REPORTING

- 8.1 Data to be acquired during the Reference Performance Tests of Sections 5 or 6 shall be as required for the normal conduct of those tests. Data from these measurements (other than summary results) need not be retained if no anomalous behavior is observed during testing.
- 8.2 The general reporting requirements for USABC testing are given in Section 4 of Appendix B, Reporting and Data

Acquisition Outline, of this manual.

- 8.3 A report shall be prepared detailing the actual vibration regimes applied, a compilation and interpretation of all data acquired, any results of detailed component failure analyses, and any recommendations for improvements in battery design, installation procedures, or test methods. Also, the pre- and post-vibration electrical performance data that confirms the adequacy of the battery design to withstand the vibration environments shall be summarized as required by 8.1.

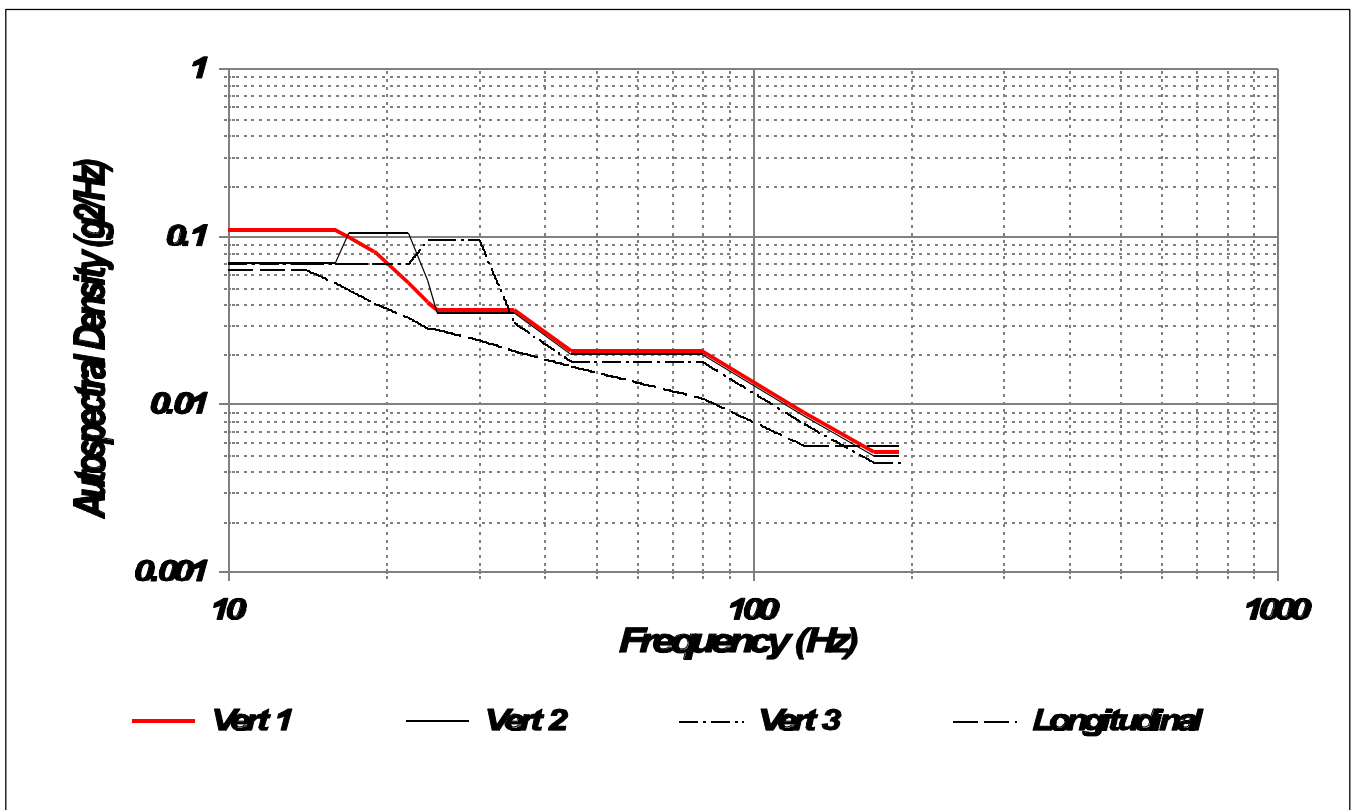

Figure 1. Vibration Spectra for Random Vibration Test